



**FinishPro 42XP**

## 2 1/2" Angled Finish Nailer



Operating Instructions  
Instrucciones de Operacion  
Mode d'Emploi

# SENCO®

Senco Brands, Inc.  
4270 Ivy Pointe Blvd.  
Cincinnati, OH 45245  
1-800-543-4596  
www.senco.com



Warnings for the safe use of this tool are included in this manual.  
Los avisos para el uso seguro de esta herramienta están incluidos en este manual.  
Les consignes pour l'utilisation en toute sécurité de cet outil se trouvent dans ce manuel.

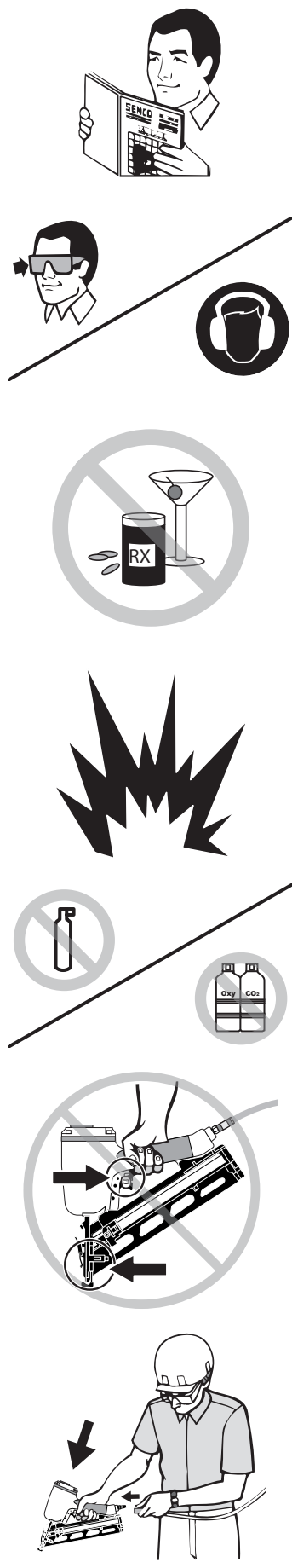
**NFD84G • Revised July 27, 2017 (Replaces 10/15/2015)**

© 2015 by Senco Brands, Inc.

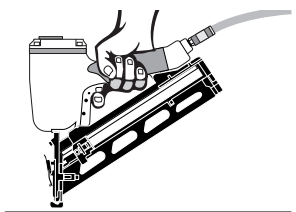

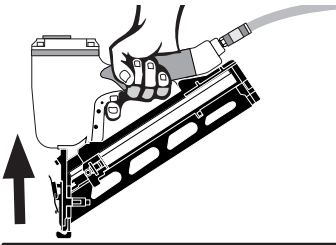
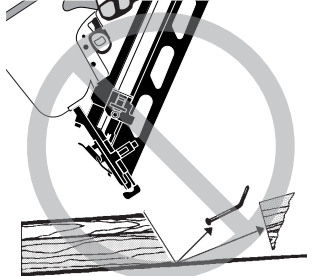
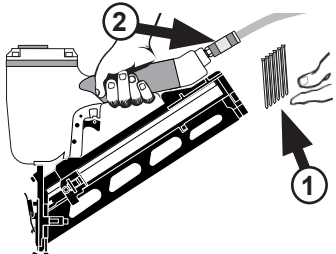
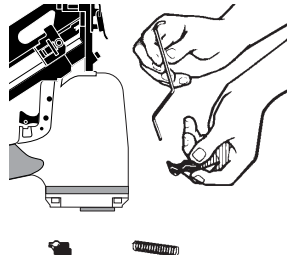
TABLE OF CONTENTS	TABLA DES MATERIAS	TABLE DES MATIERES
Employer's Responsibilities..... 2	Responsabilidades Del Empleador ..... 2	Responsabilites De L'employeur ..... 2
Safety Warnings ..... 3	Avisos de Seguridad..... 3	Avertissements de Sécurité..... 3
Tool Use..... 7	Use de la Herramienta..... 7	Utilisation d l'Outil..... 7
Maintenance ..... 9	Mantenimiento ..... 9	Entretien ..... 9
Troubleshooting..... 10	Identificación de Fallas..... 10	Dépannage..... 10
Accessories ..... 10	Accesorios ..... 10	Accessoires ..... 10
Technical Specifications .....11	Especificaciones Tecnicas.....11	Specifications Techniques .....11
Fastener Specifications .....11	Especificaciones Del Sujetador.....11	Spécifications Des Attaches .....11
Limited Warranty.....12	Limited Warranty.....12	Limited Warranty.....12

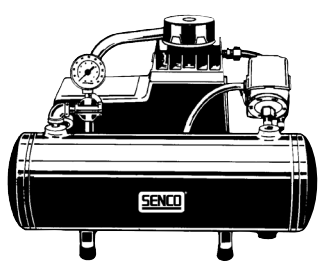
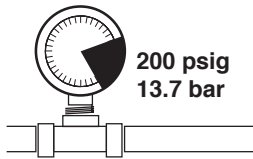
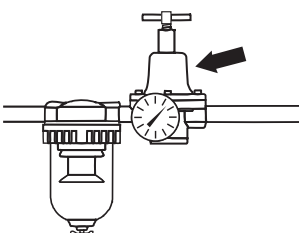
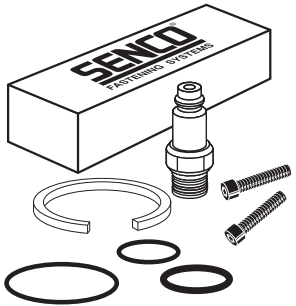
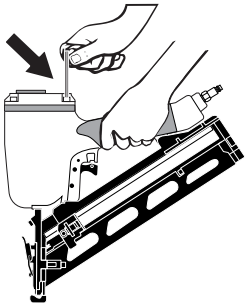
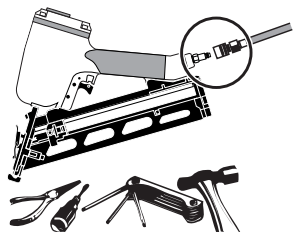


EMPLOYER'S RESPONSIBILITIES	RESPONSABILIDADES DEL EMPLEADOR	RESPONSABILITES DE L'EMPLOYEUR
<p>Employer must enforce compliance with the safety warnings and all other instructions which accompany this tool as shipped from the manufacturer.</p> <p>Keep this manual available for use by all people assigned to the use of this tool.</p> <p>For personal safety and proper operation of this tool, read and understand all of these instructions carefully.</p>	<p>El empleador debe hacer cumplir las advertencias de seguridad y todas las otras instrucciones que acompañan a esta herramienta como se la despacha desde el fabricante.</p> <p>Mantenga este manual disponible para que lo usen todas las personas destinadas a hacer uso de esta herramienta.</p> <p>Por razones de seguridad personal y la adecuada operación de esta herramienta, lea y comprenda todas estas instrucciones cuidadosamente.</p>	<p>L'employeur doit faire appliquer les consignes de sécurité et toutes les autres instructions qui accompagnent cet outil tel qu'il est livré par son constructeur.</p> <p>Ayez ce manuel à la disposition de toutes les personnes chargées d'utiliser cet outil.</p> <p>Pour assurer la sécurité personnelle et le bon emploi de cet outil, lisez et assimilez soigneusement toutes ces instructions.</p>

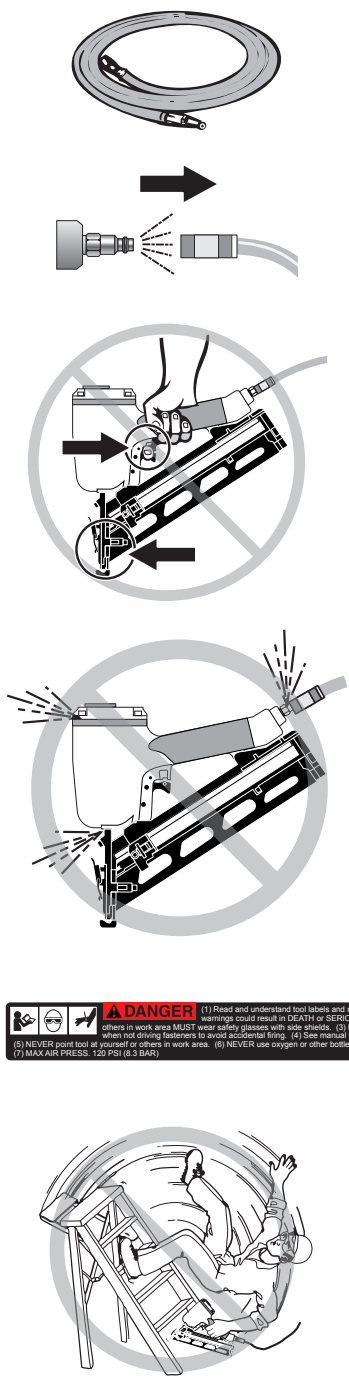


SAFETY WARNINGS	AVISOS DE SEGURIDAD	AVERTISSEMENTS DE SÉCURITÉ
<p style="text-align: center;"><b>Warning!</b></p> <ul style="list-style-type: none"> <li>• Read and understand tool labels and manual. Failure to follow warnings could result in DEATH or SERIOUS INJURY.</li> </ul> <p style="text-align: center;"><b>Save These Instructions</b></p>	<p style="text-align: center;"><b>Advertencia!</b></p> <ul style="list-style-type: none"> <li>• Lea y comprenda las etiquetas y el manual de la herramienta. El incumplimiento de los avisos puede provocar la MUERTE o GRAVES LESIONES.</li> </ul> <p style="text-align: center;"><b>Guarde Estas Instrucciones</b></p>	<p style="text-align: center;"><b>Avertissement</b></p> <ul style="list-style-type: none"> <li>• Lire et assimiler les étiquettes et le manuel de l'outil. Le non respect des avertissements peut entraîner des BLESSURES GRAVES OU MORTELLES.</li> </ul> <p style="text-align: center;"><b>Conservez Ces Instructions</b></p>
<ul style="list-style-type: none"> <li>• Use safety equipment. Always wear ANSI Z87.1 safety glasses with permanently attached side shields. Dust mask, non-skid safety shoes, hard hat, or hearing protection must be used for appropriate conditions. Failure to do so could result in personal injury.</li> </ul>	<ul style="list-style-type: none"> <li>• Utilice equipos de seguridad. Use siempre anteojos de seguridad conforme a ANSI Z87.1, con protecciones laterales permanentemente colocadas. En las condiciones en las que sea necesario debe utilizarse máscara antipolvo, zapatos de seguridad antideslizantes, casco o protección auditiva. No hacerlo podría provocar lesiones personales.</li> </ul>	<ul style="list-style-type: none"> <li>• Utiliser un équipement de sécurité. Porter toujours des lunettes de protection classe ANSI Z87.1 avec leurs écrans latéraux montés en permanence. Quand les conditions le demandent, porter masque à poussières, casque, ou protection auditive. Ne pas porter les protections adéquates peut entraîner des préjudices physiques.</li> </ul>
<p style="text-align: center;"><b>Personal Safety</b></p> <ul style="list-style-type: none"> <li>• Stay alert, watch what you are doing, and use common sense when operating a power tool. Do not use tool while tired or under the influence of drugs, alcohol, or medication. A moment of inattention while operating power tools may result in serious personal injury.</li> </ul>	<p style="text-align: center;"><b>Seguridad Personal</b></p> <ul style="list-style-type: none"> <li>• Cuando utilice una herramienta de motor, manténgase alerta, preste atención a lo que está haciendo y aplique el sentido común. No use la herramienta cuando se sienta cansado o se encuentre bajo los efectos de drogas, alcohol o medicamentos. Un momento de falta de atención mientras utiliza una herramienta de motor puede ocasionar lesiones graves.</li> </ul>	<p style="text-align: center;"><b>Sécurité Corporelle</b></p> <ul style="list-style-type: none"> <li>• Soyez en bonne condition physique, soyez attentif à ce que vous faites et faites preuve de bon sens lorsque vous utilisez un outillage électrique. N'utilisez pas votre outil si vous êtes fatigué ou sous l'influence de drogues, alcool ou médicaments. Un moment d'inattention lors de l'utilisation d'un outillage électrique peut être la cause de graves blessures corporelles.</li> </ul>
<p style="text-align: center;"><b>Explosion Hazard</b></p> <ul style="list-style-type: none"> <li>• Never use tool in an explosive atmosphere or in the presence of combustible materials such as flammable liquids, gases or dust.</li> </ul>	<p style="text-align: center;"><b>Riesgo De Explosión</b></p> <ul style="list-style-type: none"> <li>• Nunca utilice la herramienta en una atmósfera explosiva o en presencia de materiales combustibles, como líquidos, gases o polvo inflamable.</li> </ul>	<p style="text-align: center;"><b>Danger D'Explosion</b></p> <ul style="list-style-type: none"> <li>• Ne jamais utiliser l'outil en atmosphère explosive ou en présence de matériaux combustibles tels que les liquides, gaz ou poussières inflammables.</li> </ul>
<ul style="list-style-type: none"> <li>• Never use oxygen, carbon dioxide or any other bottled gas as a power source for this tool; the tool will explode and cause serious injury.</li> </ul>	<ul style="list-style-type: none"> <li>• Nunca use oxígeno, anhídrido carbónico o cualquier otro gas embotellado como fuente de fuerza para esta herramienta; la herramienta explotará y producirá lesiones graves.</li> </ul>	<ul style="list-style-type: none"> <li>• N'utilisez jamais de l'oxygène, du gaz carbonique ou tout autre gaz en bouteille comme source d'énergie pour cet outil ; cela causerait l'explosion de l'outil et entraînerait de graves blessures.</li> </ul>
<ul style="list-style-type: none"> <li>• Always remove finger from trigger when not driving fasteners. Never carry the tool with finger on or under trigger. Tool will eject a fastener if the safety element is bumped.</li> </ul>	<ul style="list-style-type: none"> <li>• Siempre quite el dedo del gatillo cuando no esté disparando clavos. Nunca cargue la herramienta con el dedo sobre o por debajo del gatillo. La herramienta disparará un clavo si se golpea el elemento de seguridad.</li> </ul>	<ul style="list-style-type: none"> <li>• Otez le doigt de la détente lorsque vous n'enfoncez pas d'agrafes. Ne transportez jamais l'outil avec le doigt sur la détente ; l'outil tirera une agrafe si le palpeur de sécurité par pression est heurté.</li> </ul>
<ul style="list-style-type: none"> <li>• Always assume the tool contains fasteners. No horseplay. Respect the tool as a working implement.</li> <li>• Keep tool pointed away from yourself and others and connect air to tool.</li> <li>• Tools shall be operated at the lowest pressure needed for the application. This will reduce noise levels, part wear, and energy use.</li> </ul>	<ul style="list-style-type: none"> <li>• Suponga siempre que la herramienta contiene sujetadores. Absténgase de practicar juegos rudos o bromas. Respete a la herramienta como un implemento de trabajo.</li> <li>• Mantenga la herramienta apuntando en dirección opuesta de usted y de otros y conecte el aire a la manguera.</li> <li>• Esto reducirá el nivel de ruido, el desgaste de las partes, y el uso de energía.</li> </ul>	<ul style="list-style-type: none"> <li>• Toujours supposer que l'outil contient encore des clous. Respecter l'outil comme instrument de travail.</li> <li>• Maintenez l'outil pointé à l'écart d'autres personnes et de vous-même et raccordez l'air à l'outil.</li> <li>• Les outils doivent être utilisés à la pression la plus faible requise pour le travail à faire. Cela réduira le niveau de bruit, l'usure de l'outil et la demande en énergie.</li> </ul>

	SAFETY WARNINGS	AVISOS DE SEGURIDAD	AVERTISSEMENTS DE SÉCURITÉ
	<ul style="list-style-type: none"> <li>• Drive fasteners into work surface only; never into materials too hard to penetrate.</li> </ul>	<ul style="list-style-type: none"> <li>• Dispare los sujetadores solamente en la superficie de trabajo, nunca en materiales que sean muy duros para penetrarlos.</li> </ul>	<ul style="list-style-type: none"> <li>• Cloutez uniquement dans la surface de travail ; jamais dans des matériaux trop durs à pénétrer.</li> </ul>
	<ul style="list-style-type: none"> <li>• Do not drive fasteners on top of other fasteners or with the tool at too steep of an angle; the fasteners can ricochet and hurt someone.</li> </ul>	<ul style="list-style-type: none"> <li>• No dispare los sujetadores uno encima uno del otro o con la herramienta en un ángulo muy empinado; los sujetadores pueden rebotar y herir a alguien.</li> </ul>	<ul style="list-style-type: none"> <li>• N'enfoncez pas des projectiles sur d'autres projectiles ou avec l'outil à un angle trop grand ; les projectiles peuvent ricocher et blesser quelqu'un.</li> </ul>
	<ul style="list-style-type: none"> <li>• When using tool, care should be taken due to possibility of tool recoil after a fastener is driven. If safety element is unintentionally allowed to re-contact work surface following a recoil, an unwanted fastener will be driven. Therefore, allow tool to recoil completely off work surface after a fastener is driven to avoid this condition. Do not push safety element on work surface until a second fastener is desired.</li> </ul>	<ul style="list-style-type: none"> <li>• Cuando se use la herramienta se deben tomar precauciones, debido a la posibilidad que esta rebote. Si al rebotar y el seguro no intencionalmente volviera a tocar la superficie de trabajo, la herramienta pudiera disparar un segundo sujetador no deseado. Por lo tanto para evitar esta condicion permita a la herramienta rebotar fuera de la superficie de trabajo. No presione el seguro en la superficie de trabajo hasta que desee disparar otro sujetador.</li> </ul>	<ul style="list-style-type: none"> <li>• Lors de l'utilisation de l'appareil, faites attention car le rebond de l'appareil peut déclencher le tir d'un projectile si l'élément de sécurité "de contact" est réarmé. Afin d'éviter cela, laissez l'appareil rebondir sans essayer de le maintenir en contact avec la surface de travail.</li> </ul>
	<ul style="list-style-type: none"> <li>• Do not drive fasteners close to the edge of the work surface. The workpiece is likely to split and the fastener could fly free or ricochet and hit someone.</li> </ul>	<ul style="list-style-type: none"> <li>• No clave sujetadores cerca del borde de la superficie de trabajo. La pieza de trabajo seguramente se partirá y el sujetador podría volar solo o rebotar y pegarle a alguien.</li> </ul>	<ul style="list-style-type: none"> <li>• N'enfoncez pas les projectiles près du bord de la surface de travail. La pièce sur laquelle vous travaillez se fendrait probablement et les projectiles pourraient être projetés ou ricocher et blesser quelqu'un.</li> </ul>
	<ul style="list-style-type: none"> <li>• Tool may eject a fastener when connected to air supply; therefore,             <ol style="list-style-type: none"> <li>① remove all fasteners from tool</li> <li>② before connecting air.</li> </ol> </li> </ul>	<ul style="list-style-type: none"> <li>• La herramienta puede expulsar un clavo al estar conectada al suministro de aire, por lo tanto,             <ol style="list-style-type: none"> <li>① remueva todos los clavos</li> <li>② antes de conectar la herramienta al suministro de aire.</li> </ol> </li> </ul>	<ul style="list-style-type: none"> <li>• L'outil peut éjecter un projectile quand il est raccordé à l'alimentation en air, par conséquent,             <ol style="list-style-type: none"> <li>① enlevez tous les projectiles</li> <li>② avant le raccordement à l'air.</li> </ol> </li> </ul>
	<ul style="list-style-type: none"> <li>• Never use tool if safety element, trigger or springs have become inoperable, missing or damaged. Do not tamper with or remove safety element, trigger, or springs.</li> </ul>	<ul style="list-style-type: none"> <li>• Nunca use la herramienta si el disparo, la seguridad o los resortes se han vuelto inoperantes, si faltan o están dañados. No maneje indebidamente o remueva la seguridad, el disparador o los resortes.</li> </ul>	<ul style="list-style-type: none"> <li>• N'utilisez jamais l'outil si le palpeur de sécurité, la détente ou les ressorts sont inutilisables, manquants ou endommagés. N'altérez pas ceux-ci et ne les enlevez pas.</li> </ul>

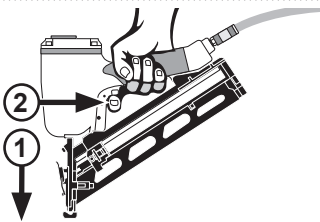
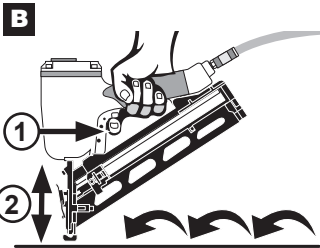
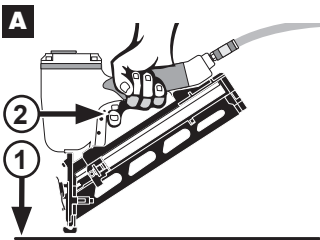
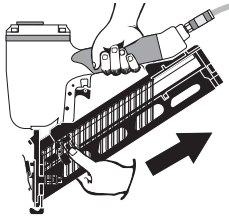
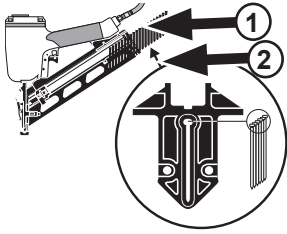


SAFETY WARNINGS	AVISOS DE SEGURIDAD	AVERTISSEMENTS DE SÉCURITÉ
<ul style="list-style-type: none"> <li>• Disconnect tool from air before doing tool maintenance, clearing a jammed fastener, leaving work area, moving tool to another location, or handing the tool to another person.</li> </ul>	<ul style="list-style-type: none"> <li>• Desconecte la herramienta del aire antes de darle mantenimiento a la herramienta de arreglar un sujetador atascado, de dejar le área de trabajo o de mover la herramienta a otro lugar, o entregar la herramienta a otro persona.</li> </ul>	<ul style="list-style-type: none"> <li>• Couper l'arrivée d'air comprimé avant toute intervention sur l'outil (maintenance ou dégagement d'un clou coincé) ou avant de vous éloigner du secteur de travail ou avant de déplacer l'appareil, ou encore avant de le donner à une autre personne.</li> </ul>
<ul style="list-style-type: none"> <li>• Make sure all screws and caps are securely tightened at all times. Make daily inspections for free movement of trigger and safety element. Never use the tool if parts are missing or damaged.</li> </ul>	<ul style="list-style-type: none"> <li>• Asegúrese de que todos los tornillos y tapas estén asegurados en forma apretada, en todo momento. Realize inspecciones diarias asegurandose que el Gatillo y el seguro se mueven libremente. Nunca use la herramienta si hay partes que faltan o que están dañadas.</li> </ul>	<ul style="list-style-type: none"> <li>• Assurez-vous que tous les vis et couvercles soient serrés en permanence. Par une inspection journalière, assurez-vous que la détente et le palpeur de sécurités fonctionnent librement. N'utilisez jamais l'outil si des pièces manquent ou sont endommagées.</li> </ul>
<ul style="list-style-type: none"> <li>• Use only parts, fasteners, and accessories recommended or sold by SENCO. Do not modify tool without authorization from SENCO.</li> </ul>	<ul style="list-style-type: none"> <li>• Use solamente partes, sujetadores y accesorios recomendados o vendidos por SENCO. No modifique la herramienta sin autorización de SENCO.</li> </ul>	<ul style="list-style-type: none"> <li>• Utilisez uniquement les pièces de rechange, accessoires et projectiles recommandés ou vendus par SENCO. Ne modifiez jamais un appareil sans l'autorisation explicite de SENCO.</li> </ul>
<ul style="list-style-type: none"> <li>• Use only clean, dry, regulated compressed air at recommended pressure.</li> </ul>	<ul style="list-style-type: none"> <li>• Use solamente aire comprimido limpio, seco y regulado a las presiones recomendadas.</li> </ul>	<ul style="list-style-type: none"> <li>• Utilisez uniquement de l'air comprimé réglé, propre et sec, à la pression recommandée.</li> </ul>
<ul style="list-style-type: none"> <li>• Do not connect tools to air pressure that potentially exceeds 200 psig or 13.7 bar.</li> </ul>	<ul style="list-style-type: none"> <li>• Las herramientas no deben ser conectadas a presión de aire que potencialmente exceda 200 psig o 13,7 bar.</li> </ul>	<ul style="list-style-type: none"> <li>• Les appareils ne doivent être raccordés qu'à un réseau dont il est assuré que la pression maximale ne peut dépasser 200 psig ou 13,7 bar.</li> </ul>
<ul style="list-style-type: none"> <li>• Air compressors used to supply compressed air to this tool must comply with requirement ANSI/ASME B 19.1-1995 (U.S.), "Safety Standard For Air Compressor Systems."</li> </ul>	<ul style="list-style-type: none"> <li>• Los compresores para aire, utilizados para suministrar aire comprimido a esta herramienta deben cumplir con el requisito ANSI/ASME B 19,1 -1995 (USA), "Estandards de Seguridad para Sistemas de aire comprimido."</li> </ul>	<ul style="list-style-type: none"> <li>• Les compresseurs d'air comprimé utilisés pour l'alimentation en air comprimé de cet outil doivent se conformer à la norme ANSI/ASME B 19,1 -1995 (U.S.) "Normes de Sécurité pour les Systèmes de compresseurs d'air."</li> </ul>



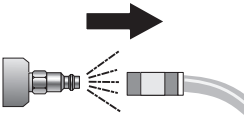
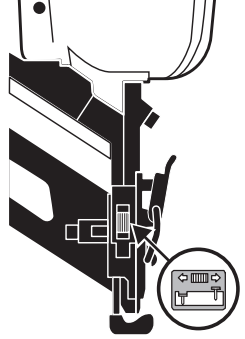
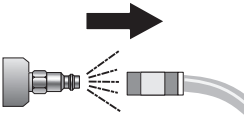
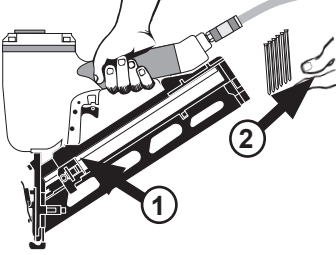
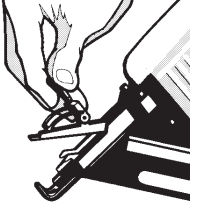
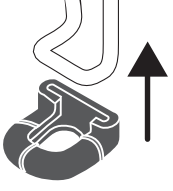
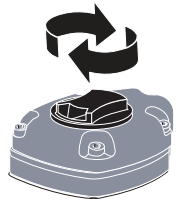
Safety First.  The only way to work.®

SAFETY WARNINGS	AVISOS DE SEGURIDAD	AVERTISSEMENTS DE SÉCURITÉ
<ul style="list-style-type: none"> <li>• Air hose must have a minimum working pressure rating of 150 psig (10.3 bar) or 150% of the maximum pressure produced in the system, whichever is higher.</li> </ul>	<ul style="list-style-type: none"> <li>• La manguera para aire debe tener una capacidad mínima de presión para trabajo de 150 psig (10,3 bar) o 150% de la presión máxima producida por el sistema, cualquiera que sea la mayor.</li> </ul>	<ul style="list-style-type: none"> <li>• Le tuyau d'alimentation doit résister à une pression minimum de travail de 150 psig (10,3 bar) ou 150% de la pression maximum produite dans le système, quelle que soit celle qui est la plus élevée.</li> </ul>
<ul style="list-style-type: none"> <li>• The tool and air supply hose must have a hose coupling such that all pressure is removed from the tool when the coupling joint is disconnected.</li> </ul>	<ul style="list-style-type: none"> <li>• La herramienta y la manguera del suministro de aire deben tener un acople de manera que toda la presión sea removida de la herramienta cuando se desconecta la junta del acople.</li> </ul>	<ul style="list-style-type: none"> <li>• L'outil et le tuyau d'alimentation en air doivent comporter un raccord agencé de telle façon que toute la pression est enlevée de l'outil quand le raccord est séparé de l'outil.</li> </ul>
<ul style="list-style-type: none"> <li>• Do not load fasteners with trigger or safety element depressed.</li> </ul>	<ul style="list-style-type: none"> <li>• No cargue los sujetadores con el disparo o la seguridad</li> </ul>	<ul style="list-style-type: none"> <li>• Ne chargez pas les clous en appuyant sur la détente ou sur le palpeur de sécurité.</li> </ul>
<ul style="list-style-type: none"> <li>• Never use a tool that leaks air or needs repair.</li> </ul>	<ul style="list-style-type: none"> <li>• Nunca use una herramienta que tenga escapes de aire o que necesite ser reparada.</li> </ul>	<ul style="list-style-type: none"> <li>• N'utilisez jamais un outil qui a des fuites d'air ou qui a besoin d'être réparé.</li> </ul>
<ul style="list-style-type: none"> <li>• Do not use tool without danger label on tool. If label is missing, damaged or unreadable, contact your SENCO representative to obtain a new label.</li> </ul>	<ul style="list-style-type: none"> <li>• No use la herramienta sin la etiqueta de Avisos de Seguridad. Si la etiqueta esta dañada, no se puede leer o falta completamente. Comuníquese con su representante de SENCO para obtener una etiqueta nueva.</li> </ul>	<ul style="list-style-type: none"> <li>• N'utilisez pas l'appareil sans l'étiquette de sécurité. Si l'étiquette est manquante, endommagée ou illisible, prendre contact avec votre représentant SENCO pour en obtenir une autre.</li> </ul>
<ul style="list-style-type: none"> <li>• Always place yourself in a firmly balanced position when using or handling the tool.</li> </ul>	<ul style="list-style-type: none"> <li>• Siempre colóquese usted en una posición firmemente equilibrada cuando use o maneje la herramienta.</li> </ul>	<ul style="list-style-type: none"> <li>• Veiller à toujours être en position stable pour toute utilisation ou intervention sur l'appareil.</li> </ul>
<ul style="list-style-type: none"> <li>• For information on the "SENCO Safety First Program," contact your SENCO representative.</li> </ul>	<ul style="list-style-type: none"> <li>• Para información sobre el "Programa de SENCO la Seguridad es Primero" comuníquese con su representante de SENCO.</li> </ul>	<ul style="list-style-type: none"> <li>• Prendre contact avec votre représentant SENCO tout renseignement sur "Le Programme SENCO de Première Urgence".</li> </ul>

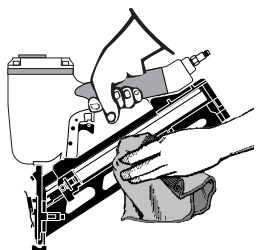
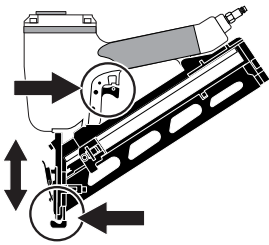
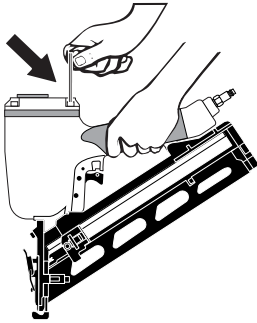


TOOL USE	USE DE LA HERRAMIENTA	UTILISATION D L'OUTIL
<ul style="list-style-type: none"> <li>• Read section titled "Safety Warnings," before using tool.</li> </ul>	<ul style="list-style-type: none"> <li>• Lea la sección titulada "Avisos de Seguridad" antes de usar la herramienta.</li> </ul>	<ul style="list-style-type: none"> <li>• Avant d'utiliser l'outil, lisez le chapitre intitulé "Consignes de Sécurité."</li> </ul>
<p><b>To Load:</b></p> <ol style="list-style-type: none"> <li>1 Connect air supply.</li> <li>2 Insert strip of nails into rear of magazine. <ul style="list-style-type: none"> <li>□ Use only genuine SENCO fasteners (see "Fastener Specifications" on page 11).</li> </ul> </li> </ol> <ul style="list-style-type: none"> <li>• <b>Do not load with workpiece contact (safety element) or trigger depressed.</b></li> </ul>	<p><b>Para cargar:</b></p> <ol style="list-style-type: none"> <li>1 Conecte el aire.</li> <li>2 Inserte la tira de clavos en la parte de atrás del área de almacenamiento. <ul style="list-style-type: none"> <li>□ Use solamente sujetadores SENCO auténticos.</li> </ul> </li> </ol> <ul style="list-style-type: none"> <li>• <b>No cargue con el disparo o la seguridad oprimidos.</b></li> </ul>	<p><b>Pour charger:</b></p> <ol style="list-style-type: none"> <li>1 Connectez à la source d'air comprimé.</li> <li>2 Introduisez une bande de clous dans la partie arrière du magasin. <ul style="list-style-type: none"> <li>□ Utilisez uniquement les véritables clous SENCO.</li> </ul> </li> </ol> <ul style="list-style-type: none"> <li>• <b>Veillez à ne pas appuyer sur le palpeur de sécurité ou sur la détente quand vous chargez.</b></li> </ul>
<ul style="list-style-type: none"> <li>• Pull feeder shoe back.</li> </ul>	<ul style="list-style-type: none"> <li>• Tire la zapata del alimentador hacia atrás.</li> </ul>	<ul style="list-style-type: none"> <li>• Tirez le poussoir en arrière.</li> </ul>
<ul style="list-style-type: none"> <li>• With a Contact-Actuation ("Dual-Action") trigger, nails can be driven two ways:</li> </ul>	<ul style="list-style-type: none"> <li>• Las herramientas con gatillo de Acción por Contacto (Acción Dual) pueden ser disparadas de dos maneras:</li> </ul>	<ul style="list-style-type: none"> <li>• Les outils avec Détente par Contact (Double Action) peuvent être utilisés de deux façons:</li> </ul>
<p><b>A</b> The first way:</p> <ol style="list-style-type: none"> <li>1 Press the workpiece contact (safety element) against the work surface.</li> <li>2 Pull the trigger and the fastener is driven.</li> </ol>	<p><b>A</b> La primera es la siguiente:</p> <ol style="list-style-type: none"> <li>1 Ubique el elemento de contacto de la pieza de trabajo contra la pieza de trabajo.</li> <li>2 Oprima el gatillo para hincar un clavo.</li> </ol>	<p><b>A</b> Première façon:</p> <ol style="list-style-type: none"> <li>1 Placez l'élément de contact contre la pièce.</li> <li>2 Appuyez sur la détente pour éjecter un clou.</li> </ol>
<p><b>B</b> The second way:</p> <ol style="list-style-type: none"> <li>1 Pull trigger.</li> <li>2 Depress workpiece contact element against work surface and drive a fastener. Each time you push the workpiece contact (safety element) against the work surface, a fastener is driven.</li> </ol> <ul style="list-style-type: none"> <li>• This mode of operation is preferred when you desire high production, rapid fastener placement.</li> </ul>	<p><b>B</b> La segunda es la siguiente:</p> <ol style="list-style-type: none"> <li>1 Oprima el gatillo.</li> <li>2 Ubique el elemento de contacto de la pieza de trabajo contra la superficie de trabajo e hince un clavo. Cada vez que presione el elemento de contacto de la pieza de trabajo (elemento de seguridad) contra la superficie de trabajo se dispara un clavo.</li> </ol> <ul style="list-style-type: none"> <li>• Este es el método de operación preferido cuando se busca una gran producción e hincar clavos rápidamente.</li> </ul>	<p><b>B</b> Deuxième façon:</p> <ol style="list-style-type: none"> <li>1 Appuyez sur la détente.</li> <li>2 Placez l'élément de contact avec la pièce contre la surface de travail et éjectez un clou. Chaque fois que vous appliquez l'élément de contact (dispositif de sécurité) avec la pièce contre la surface de travail, une attache est éjectée.</li> </ol> <ul style="list-style-type: none"> <li>• Ce mode d'utilisation est idéal lorsque vous voulez éjecter des attaches rapidement et à répétition.</li> </ul>
<ul style="list-style-type: none"> <li>• With a Sequential Actuation (Restrictive) trigger, fasteners can only be driven one way:</li> </ul> <ol style="list-style-type: none"> <li>1 Press the workpiece contact (safety element) against the work surface.</li> <li>2 Pull the trigger.</li> </ol> <ul style="list-style-type: none"> <li>• This mode of operation is helpful when you require precise fastener placement.</li> </ul>	<ul style="list-style-type: none"> <li>• En el modo de activación secuencial (restrictivo), los clavos pueden hincarse de una sola manera:</li> </ul> <ol style="list-style-type: none"> <li>1 Ubique el elemento de contacto de la pieza de trabajo contra la pieza de trabajo.</li> <li>2 Oprima el gatillo.</li> </ol> <ul style="list-style-type: none"> <li>• Este método de operación es útil cuando desea hincar clavos con precisión.</li> </ul>	<ul style="list-style-type: none"> <li>• À l'aide d'une détente séquentielle (restrictive), les attaches ne peuvent être éjectées que d'une seule façon.</li> </ul> <ol style="list-style-type: none"> <li>1 Placez l'élément de contact contre la pièce.</li> <li>2 Appuyez sur la détente.</li> </ol> <ul style="list-style-type: none"> <li>• Ce mode d'utilisation est pratique lorsque vous voulez éjecter des attaches avec précision.</li> </ul>
<p>Read the "Customer Satisfaction and Safety Reminder" (CSSR) in the tool and fastener boxes for safety information regarding the Contact-Actuation and Sequential trigger modes. Under certain conditions, the Sequential trigger mode may reduce the possibility of injury to you or to others working with you.</p>	<p>Lea el "Recordatorio de Seguridad y Satisfacción del Cliente" (CSSR) en las cajas de la herramienta y de los sujetadores para obtener información de seguridad referente a los modos de activación Por contacto y Secuencial. Bajo determinadas condiciones, el modo de activación Secuencial puede reducir la probabilidad de que usted y otras personas que trabajen con usted sufran lesiones.</p>	<p>Lisez le "Rappel sur la satisfaction du client et la sécurité" (CSSR) sur l'outil et les boîtes de clous, à propos des consignes de sécurité sur les modes de déclenchement au Toucher et Séquentiel. Dans certaines conditions, le mode de déclenchement Séquentiel peut diminuer la possibilité de blessures, pour vous ou ceux qui travaillent à proximité.</p>

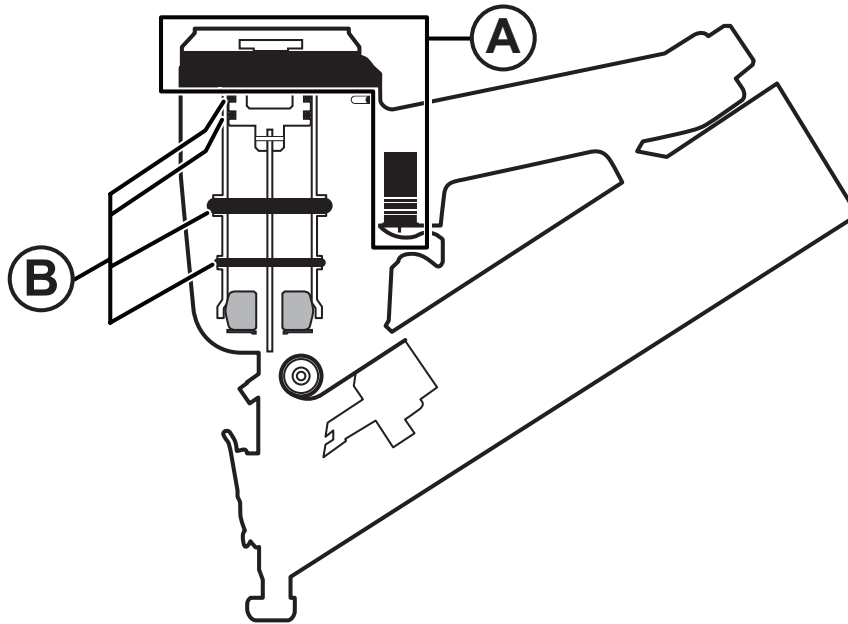


	TOOL USE	USE DE LA HERRAMIENTA	UTILISATION D L'OUTIL
	<p><b>To adjust the depth the fastener is driven:</b></p> <ul style="list-style-type: none"> <li>• Disconnect air supply.</li> </ul>	<p><b>Para ajustar la profundidad de sujetador:</b></p> <p>Desconecte el suministro de aire.</p>	<p><b>Pour ajuster la profondeur à laquelle le projectile est enfoncé:</b></p> <ul style="list-style-type: none"> <li>• Coupez l'alimentation en air.</li> </ul>
	<ul style="list-style-type: none"> <li>• Using your thumb or index finger, rotate wheel (located on side of guide body) to adjust the workpiece contact (safety element) to achieve desired depth. Adjustments are in half-turn increments. Warning: Do not extend the workpiece contact 1/4" beyond the shortest setting. This could disengage the workpiece contact and render the tool inoperable.</li> </ul>	<ul style="list-style-type: none"> <li>• Usando el dedo pulgar o el dedo indice, rote la manivela (localizada a un lado de la placa de nariz) para ajustar el seguro a la profundidad deseada. Ajustes deben incrementarse cada media vuelta. No sobrepase el seguro mas de 1/4" de pulga de la ultima marca. Esto causaria el desenganche del seguro haciendo la herramienta inoperable.</li> </ul>	<ul style="list-style-type: none"> <li>• A l'aide du pouce ou de l'index, faire tourner la molette (située sur le cote du front) pour ajuster la position du palpeur de sécurité. Paliers de réglages par 1/2 tour. Ne pas dépasser 1/4" (6,35 mm) de sortie du palpeur par rapport a la position la plus courte. Cela pourrait le désengager et rendre l'appareil inutilisable.</li> </ul>
	<p><b>Should a nail jam occur:</b></p> <ul style="list-style-type: none"> <li>• Disconnect air supply.</li> </ul>	<p><b>Si se produce un atascamiento de un clavo:</b></p> <ul style="list-style-type: none"> <li>• Desconecte el suministro de aire.</li> </ul>	<p><b>Au cas ou il se produirait un coincage de clous:</b></p> <ul style="list-style-type: none"> <li>• Coupez l'alimentation en air.</li> </ul>
	<ol style="list-style-type: none"> <li>① Release the feeder shoe and slide it forward.</li> <li>② Remove fasteners from the tool.</li> </ol>	<ol style="list-style-type: none"> <li>① Suelte el alimentador y deslícelo hacia adelante.</li> <li>② Retire los sujetadores de la herramienta.</li> </ol>	<ol style="list-style-type: none"> <li>① Relâchez le poussoir et faites le glisser vers l'avant.</li> <li>② Enlevez les projectiles.</li> </ol>
	<ul style="list-style-type: none"> <li>• Release E-Z Clear latch and open door. Remove jammed fastener. Close door and latch.</li> </ul>	<ul style="list-style-type: none"> <li>• Suelte el pestillo de alivio fácil (E-Z) y abra la puerta. Remueva el sujetador atascado. Cierre la puerta con pestillo.</li> </ul>	<ul style="list-style-type: none"> <li>• Relâchez le loquet transparent "E-Z" et ouvrez le volet de front. Enlevez le clou coincé. Fermez le volet de front et le loquet.</li> </ul>
	<ul style="list-style-type: none"> <li>• You can add a No-Mar Pad (HF0079) to the bottom of the workpiece contact (safety element) in an effort to help prevent scuffs or damage to the work surface. This pad is marked to indicate the exit point of the nail, making alignment easier.</li> </ul>	<ul style="list-style-type: none"> <li>• Un cojinete "No-Mar" (HF0079) puede ser agregado debajo del elemento de contacto con el trabajo (seguro) en un esfuerzo para ayudar a prevenir maras o daños a la superficie de trabajo. El cojinete esta marcado para indicar el punto de salida del clavo, haciendo mas fácil su alineación.</li> </ul>	<ul style="list-style-type: none"> <li>• Une protection (HF0079) peut être ajoutée à la base de l'élément de contact dans le but d'éviter de marquer ou endammer la surface du produit cloué. Un repère figure sur cette protection, indiquant le sens de sortie du clou, pour en faciliter l'alignement lors de la mise en place.</li> </ul>
	<ul style="list-style-type: none"> <li>• To adjust the direction of the exhaust air, turn the exhaust deflector to the desired location.</li> </ul>	<ul style="list-style-type: none"> <li>• Mantenga la herramienta apuntada en la dirección opuesta de usted y de otros y conecte el aire a la manguera.</li> </ul>	<ul style="list-style-type: none"> <li>• Pour changer la direction de l'échappement d'air, faire pivoter le déflecteur jusqu'à la position souhaitée.</li> </ul>





MAINTENANCE	MANTENIMIENTO	ENTRETIEN
<p style="text-align: center;"><b>WARNING</b></p> <ul style="list-style-type: none"> <li>Repairs other than those described here should be performed only by trained, qualified personnel. Contact SENCO for information at: 1-800-543-4596.</li> <li>Read section titled "Safety Warnings" before maintaining tool.</li> </ul>	<p style="text-align: center;"><b>ALERTA</b></p> <ul style="list-style-type: none"> <li>Las reparaciones, fuera de aquellas descritas aquí, deben de ser llevadas a cabo solamente por personal entrenado y calificado. Póngase en contacto con SENCO para información: 1-800-543-4596.</li> <li>Lea la sección titulada "Avisos de Seguridad" antes de darle mantenimiento a la herramienta.</li> </ul>	<p style="text-align: center;"><b>AVERTISSEMENT</b></p> <ul style="list-style-type: none"> <li>Les réparations autres que celles décrites ici doivent être réalisées uniquement par du personnel qualifié ayant reçu la formation appropriée. Pour toute information, prenez contact avec SENCO par téléphone en appelant Le Distributeur agréé.</li> <li>Lisez la section intitulée "Consignes de Sécurité" avant d'effectuer l'entretien de l'outil.</li> </ul>
<ul style="list-style-type: none"> <li>All screws should be kept tight. Loose screws result in unsafe operation and parts breakage.</li> </ul>	<ul style="list-style-type: none"> <li>Todos los tornillos tienen que mantenerse apretados. Los tornillos sueltos pueden producir una operación no segura y quebraduras de partes.</li> </ul>	<ul style="list-style-type: none"> <li>Toutes les vis doivent être maintenues serrées à fond. Les vis desserrées entraînent un manque de sûreté du fonctionnement et la rupture de pièces.</li> </ul>
<ul style="list-style-type: none"> <li>With tool disconnected, make daily inspection to assure free movement of safety element and trigger. Do not use tool if safety element or trigger sticks or binds.</li> </ul>	<ul style="list-style-type: none"> <li>Con la herramienta desconectada, haga inspecciones diarias para asegurar el movimiento libre del seguro y del gatillo. No use la herramienta si el seguro o el gatillo se atorán.</li> </ul>	<ul style="list-style-type: none"> <li>L'outil étant séparé de l'alimentation en air, effectuez une inspection journalière pour assurer le libre mouvement du palpeur de sécurité et de la détente. N'utilisez pas l'outil si le palpeur de sécurité ou la détente colle ou se coince.</li> </ul>
<ul style="list-style-type: none"> <li>Routine lubrication is not necessary.</li> <li>Do not oil.</li> </ul>	<ul style="list-style-type: none"> <li>La lubricación de rutina no es necesaria. No aceite.</li> </ul>	<ul style="list-style-type: none"> <li>La lubri cation de routine n'est pas nécessaire. N'huilez pas.</li> </ul>
<ul style="list-style-type: none"> <li>Wipe tool clean daily and inspect for wear. Use non-flammable cleaning solutions only if necessary.</li> <li><b>DO NOT SOAK.</b></li> <li><b>Caution:</b> Such solutions may damage O-rings and other tool parts.</li> </ul>	<ul style="list-style-type: none"> <li>Solamente si es necesario use soluciones para limpieza no inflamables.</li> <li><b>NO LA REMOJE.</b></li> <li><b>Precaución:</b> Tales soluciones pueden dañar los empaques y otras partes de la herramienta.</li> </ul>	<ul style="list-style-type: none"> <li>Nettoyez l'outil chaque jour à l'aide d'un chiffon et inspectez-le pour déceler une éventuelle usure. Utilisez uniquement des solvants non inflammables en cas de nécessité.</li> <li><b>NE LE FAITES PAS TREMPER!</b></li> <li><b>Attention:</b> De tels produits peuvent endommager les joints et autres pièces de l'appareil.</li> </ul>

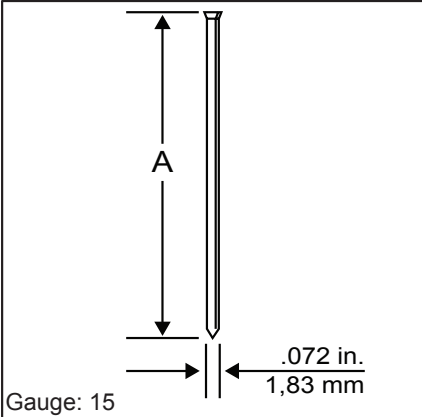


Parts Kits	
ID	Kit
(A)	YK0361
(B)	YK0362

<b>1</b>	<p><b>SYMPTOM</b> Air leak near top of tool / Sluggish operation.</p> <p><b>SOLUTION</b> Verify air supply / Tighten screws or install Repair Kit (A).</p>	<p><b>SÍNTOMA</b> El aire se escapa cerca de la parte superior de la herramienta / Operación lenta.</p> <p><b>SOLUCIÓN</b> Apriete los tornillos / Verifique el suministro de aire o instale el Juego de Partes (A).</p>	<p><b>SYMPTÔME</b> Fuite d'air près du sommet de l'outil / Fonctionnement lent.</p> <p><b>SOLUTION</b> Serrez les vis à fond / Vérifiez l'alimentation en air ou remplacez les pièces portant la lettre (A).</p>
<b>2</b>	<p><b>SYMPTOM</b> Air leak near bottom of tool / Poor return.</p> <p><b>SOLUTION</b> Clean tool / Tighten screws or install Repair Kit (B).</p>	<p><b>SÍNTOMA</b> El aire se fuga cerca de la parte inferior de la herramienta / Mal retorno.</p> <p><b>SOLUCIÓN</b> Apriete los tornillos / Limpié la herramienta o instale el Juego de Partes (B).</p>	<p><b>SYMPTÔME</b> Fuite d'air près de la base de l'outil / Retour inadéquat.</p> <p><b>SOLUTION</b> Serrez les vis à fond / Nettoyez l'outil ou remplacez les pièces portant la lettre (B).</p>
<b>3</b>	<p><b>SYMPTOM</b> Other problems.</p> <p><b>SOLUTION</b> Contact SENCO.</p>	<p><b>SÍNTOMA</b> Otros problemas.</p> <p><b>SOLUCIÓN</b> Póngase en contacto con SENCO.</p>	<p><b>SYMPTÔME</b> Autres problèmes.</p> <p><b>SOLUTION</b> Prenez contact avec SENCO.</p>

ACCESSORIES	ACCESORIOS	ACCESSOIRES
<p>SENCO offers a full line of accessories for your SENCO tools, including:</p> <ul style="list-style-type: none"> <li>• Air Compressors</li> <li>• Hose</li> <li>• Couplers</li> <li>• Fittings</li> <li>• Safety Glasses</li> <li>• Pressure Gauges</li> <li>• Lubricants</li> <li>• Regulators</li> <li>• Filters</li> </ul> <p>For more information or a complete illustrated catalogue of SENCO accessories, ask your representative for #MK336.</p>	<p>SENCO ofrece una línea completa de Accesorios para sus herramientas SENCO, incluyendo:</p> <ul style="list-style-type: none"> <li>• Compresores de Aire</li> <li>• Manguera</li> <li>• Conectores Rápidos</li> <li>• Conectores</li> <li>• Anteojos De Seguridad</li> <li>• Manómetros</li> <li>• Lubricantes</li> <li>• Reguladores</li> <li>• Filtros</li> </ul> <p>Para mas informacion ó un pour recevoir un catalogo completo ilustrado de los Accesorios SENCO, pregunte a su representante para el numero MK336.</p>	<p>SENCO offre une gamme completé d'accessoires pour votre outil SENCO incluant :</p> <ul style="list-style-type: none"> <li>• Compresseurs d'air</li> <li>• Tuyauterie</li> <li>• Raccords</li> <li>• Embouts</li> <li>• Lunettes de sécurité</li> <li>• Manomètres de pression</li> <li>• Lubrifiants</li> <li>• Régulateurs</li> <li>• Filtres</li> </ul> <p>Pour plus d'informations ou pour un catalogue illustré complet des accessoires SENCO, demander au détaillant le catalogue MK336.</p>

TECHNICAL SPECIFICATIONS		
Minimum to maximum operating pressure	70–120 psi	4.8–8.3 bar
Air Consumption (60 cycles per minute)	3.87 scfm	109.6 liter
Air Inlet	1/4 in. NPT	1/4 in. NPT
Maximum Speed (cycles per second)	4	4
Weight	4.7 lbs.	2.1 kg
Fastener Capacity	104	104
Tool size: Height	11 1/4 in.	286 mm
Tool size: Length	13 in.	330 mm
Tool size: Width: Main Body	3 1/2 in.	89 mm
ESPECIFICACIONES TECNICAS		
Presión de operación mínima y máxima	4.8–8.3 bar	70–120 psi
Consumo de aire (60 ciclos por minuto)	109.6 liter	3.87 scfm
Entrada de aire	1/4 in. NPT	1/4 in. NPT
Velocidad máxima (ciclos por segundo)	4	4
Peso	2.1 kg	4.7 lbs.
Capacidad de grapas por cargador	104	104
Tamaño de la herramienta: Altura	286 mm	11 1/4 in.
Tamaño de la herramienta: Longitud	330 mm	13 in.
Tamaño de la herramienta: Ancho (Cuerpo)	89 mm	3 1/2 in.
SPECIFICATIONS TECHNIQUES		
Pression de travail min. et max.	4.8–8.3 bar	70–120 psi
Consommation d'air (60 cycles par minute)	109.6 liter	3.87 scfm
Admission d'air	1/4 in. NPT	1/4 in. NPT
Vitesse maximum (cycles par seconde)	4	4
Poids	2.1 kg	4.7 lbs.
Capacité de projectiles par magasin	104	104
Dimensions de l'outil: hauteur	286 mm	11 1/4 in.
Dimensions de l'outil: longueur	330 mm	13 in.
Dimensions de l'outil: largeur: corps de l'appareil	89 mm	3 1/2 in.

FASTENER SPECIFICATIONS	ESPECIFICACIONES DEL SUJETADOR	SPÉCIFICATIONS DES ATTACHES																										
 <p style="text-align: center;">Gauge: 15</p>																												
		<table border="1"> <thead> <tr> <th rowspan="2">SENCO Fastener Code</th> <th colspan="2">A</th> </tr> <tr> <th>inches</th> <th>mm</th> </tr> </thead> <tbody> <tr> <td>DA15</td> <td>1-1/4</td> <td>32</td> </tr> <tr> <td>DA17</td> <td>1-1/2</td> <td>38</td> </tr> <tr> <td>DA18</td> <td>1-5/8</td> <td>41</td> </tr> <tr> <td>DA19</td> <td>1-3/4</td> <td>45</td> </tr> <tr> <td>DA21</td> <td>2</td> <td>50</td> </tr> <tr> <td>DA23</td> <td>2-1/4</td> <td>57</td> </tr> <tr> <td>DA25</td> <td>2-1/2</td> <td>64</td> </tr> </tbody> </table>	SENCO Fastener Code	A		inches	mm	DA15	1-1/4	32	DA17	1-1/2	38	DA18	1-5/8	41	DA19	1-3/4	45	DA21	2	50	DA23	2-1/4	57	DA25	2-1/2	64
SENCO Fastener Code	A																											
	inches	mm																										
DA15	1-1/4	32																										
DA17	1-1/2	38																										
DA18	1-5/8	41																										
DA19	1-3/4	45																										
DA21	2	50																										
DA23	2-1/4	57																										
DA25	2-1/2	64																										

**Limited Warranty**  
**SENCO® Pneumatic, DuraSpin®, Cordless Tools**  
**& Compressors**

Senco Products, Inc. ("SENCO") designs and constructs its products using the highest standards of material and workmanship. SENCO warrants to the original retail purchaser that the following products will be free from defects in material or workmanship for the warranty period specified below:

<b>Pneumatic tools *</b> Five Years	<b>Fusion Tools</b> Two Years	<b>Combo Kit Tools</b> One Year	<b>GasTools</b> Two Years
<b>Duraspin Tools</b> One Year	<b>Air Compressors</b> One Year	<b>Multi-Blow Hand Nailers</b> One Year	<b>Stapling Hammers</b> One Year

\* = Both XP and Pro

During the warranty period (which begins on the purchase date), SENCO will repair or replace, at SENCO's option and expense, any product or part that is defective in materials or workmanship after examination by a SENCO Authorized Warranty Service Center, subject to the exceptions, exclusions and limitations described below. Any replacement product or part will carry a warranty for the balance of the warranty period applicable to the replaced product or part. A DATED SALES RECEIPT OR PROOF OF PURCHASE FROM THE ORIGINAL RETAIL PURCHASER IS REQUIRED TO MAKE A WARRANTY CLAIM. Warranty registration also is required and can be accomplished through on-line Product Registration at [www.senco.com](http://www.senco.com) or by completing and returning the postage paid warranty registration form included with your Operator's manual/parts chart information, found inside the product carton. To make a warranty claim, you must return the product, with proper receipt/proof of purchase and return transportation charges prepaid, to a SENCO Authorized Warranty Service Center. A list of SENCO Authorized Warranty Service Centers can be found at [www.senco.com](http://www.senco.com) or by calling 1-800-543-4596 toll free. SENCO will perform its obligations under this warranty, within a reasonable time after approval of the warranty claim.

**Wheelbarrow Compressors:**

- Subject to the exceptions, exclusions and limitations described below, SENCO warrants that the compressor pump will be free from defects in materials and workmanship for two years after the purchase date.
- Defective parts of the compressor pump not subject to normal wear and tear will be repaired or replaced, at SENCO's option, during the two year warranty period. If SENCO determines that repair or replacement is not feasible, SENCO will refund the purchase price less reasonable depreciation based on actual use.

**SENCO Cordless:**

- Subject to the exceptions, exclusions and limitations described below, SENCO warrants that the SENCO Cordless tool will be free from defects in materials and workmanship for two years after the purchase date.
- SENCO warrants that the batteries and chargers used with SENCO Cordless tools will be free from defects in material and workmanship for one year after the purchase date.

**WARRANTY EXCLUSIONS**

The following warranty exclusions apply:

- Normal wear parts are not covered under this warranty. Normal wear parts include, for example, isolators, drive belts, air filters, rubber o-rings, seals, driver blades, piston stops, and piston/driver assembly.
- This warranty does not cover parts damaged due to normal wear, misapplication, misuse, accidents, operation at other than recommended speeds or voltage (electric units only), improper storage, or damage resulting during shipping.
- Products used in production/industrial applications as defined by SENCO are excluded from this warranty.
- Labor charges or loss or damage resulting from improper operation, maintenance or repairs are not covered by this warranty.
- SENCO does not warrant the Wheelbarrow Compressor Engine/Motor, but the Compressor Engine/Motor may be covered under a warranty offered by its manufacturer.

**GENERAL WARRANTY CONDITIONS**

This warranty will be honored, only if:

- Clean, dry, regulated compressed air has been used, at air pressure not exceeding the maximum indicated on the tool casting;
- No evidence of abuse, abnormal conditions, accident, neglect, misuse or improper modifications or storage of the product; and
- No Deviation from operating instructions, specifications, and maintenance schedules exists (read Operator Manual for use, specifications, and maintenance instructions).

THIS WARRANTY IS THE ONLY WARRANTY ON THE PRODUCT, AND SENCO DISCLAIMS ALL OTHER WARRANTIES. ANY IMPLIED WARRANTIES WILL BE LIMITED IN DURATION TO THE APPLICABLE WARRANTY PERIOD SPECIFIED ABOVE. SOME STATES DO NOT ALLOW LIMITATIONS ON HOW LONG AN IMPLIED WARRANTY LASTS, SO THE ABOVE LIMITATION MAY NOT APPLY TO YOU. YOUR REMEDIES ARE SOLELY AND EXCLUSIVELY AS STATED ABOVE. SENCO SHALL IN NO EVENT BE LIABLE FOR INCIDENTAL, CONSEQUENTIAL, INDIRECT, OR SPECIAL DAMAGES. SOME STATES DO NOT ALLOW THE EXCLUSION OR LIMITATION OF INCIDENTAL OR CONSEQUENTIAL DAMAGES, SO THE ABOVE LIMITATION OR EXCLUSION MAY NOT APPLY TO YOU. IN NO EVENT, WHETHER AS A RESULT OF A BREACH OF CONTRACT, WARRANTY, TORT (INCLUDING NEGLIGENCE) OR OTHERWISE, SHALL SENCO'S LIABILITY EXCEED THE PRICE OF THE PRODUCT WHICH HAS GIVEN RISE TO THE CLAIM OR LIABILITY. ANY LIABILITY CONNECTED WITH THE USE OF THIS PRODUCT SHALL TERMINATE UPON THE EXPIRATION OF THE WARRANTY PERIOD SPECIFIED ABOVE. NO EMPLOYEE OR REPRESENTATIVE OF SENCO OR ANY DISTRIBUTOR OR DEALER IS AUTHORIZED TO MAKE ANY CHANGE OR MODIFICATION TO THIS WARRANTY.

This warranty gives you specific legal rights, and you may also have other rights which vary from state to state.

**REPLACEMENT OF TOOL DUE TO NATURAL DISASTER**

SENCO will replace any tool destroyed by an Act of God such as flood, earthquake, hurricane or other disaster resulting only from the forces of nature. Such a claim will be honored provided that such original retail purchaser had previously submitted a completed warranty registration card for the tool, and then submits proof of ownership and an acceptable statement describing such Act of God documented by an insurance carrier, police department, or other official governmental source. To obtain instructions for filing a claim call 1-800-543-4596.

**CUSTOMER SATISFACTION**

One hundred percent customer satisfaction is our #1 goal. If for any reason the product does not perform to the original purchaser's satisfaction, it can be returned to the place of purchase **within thirty days** with dated sales receipt for a full refund of the purchase price.