

1/4" Impact Driver



Operator's Manual

Record the date of purchase in your manual for future reference.

Date of purchase: _____

For technical support, email techsupport@rikontools.com - For parts questions, email parts@rikontools.com

TABLE OF CONTENTS

<u>SECTION</u>	<u>PAGE</u>
Safety Instructions.....	3-7
Specifications.....	8
Overview.....	9
Instructions.....	10-11
Maintenance.....	11
Troubleshooting.....	12
Notes.....	12
Warranty.....	13
Parts Diagram.....	14
Parts List.....	15

NOTE: The specifications, photographs, drawings and information in this manual represent the current machine model when the manual was prepared. Changes and improvements may be made at any time, with no obligation on the part of Rikon Power Tools to modify previously delivered units. Reasonable care has been taken to ensure that the information in this manual is correct, to provide you with the guidelines for the proper safety, assembly and operation of this machine.

This owner's manual is not a teaching aid and is intended to show assembly, adjustments, and general use.

SAVE THESE INSTRUCTIONS.
Refer to them often.

PROPOSITION 65 WARNING

 **WARNING:** Drilling, sawing, sanding or machining wood products can expose you to wood dust, a substance known to the State of California to cause cancer. Avoid inhaling wood dust or use a dust mask or other safeguards for personal protection. For more information go to www.P65Warnings.ca.gov.

 **WARNING:** This product contains the following ingredients for which the State of California has found to cause cancer, birth defects or other reproductive harm, which would require warning under the statute – Cobalt Oxide, Nickel Oxide, Carbon Black and Lithium Nickelate. For more information go to www.P65Warnings.ca.gov.

SAFETY INSTRUCTIONS

IMPORTANT! Safety is the single most important consideration in the operation of this equipment. The following instructions must be followed at all times. Failure to follow all instructions listed below may result in electric shock, fire, and/or serious personal injury.

There are certain applications for which this tool was designed. We strongly recommend that this tool not be modified and/or used for any other application other than that for which it was designed. If you have any questions about its application, do not use the tool until you have contacted us and we have advised you.

The purpose of safety symbols is to attract your attention to possible dangers. The safety symbols and the explanations with them deserve your careful attention and understanding. The symbol warnings do not, by themselves, eliminate any danger. The instructions and warnings they give are no substitutes for proper accident prevention measures.

 **WARNING:** Be sure to read and understand all safety instructions in this manual, including all safety alert symbols such as “DANGER,” ”WARNING,” and “CAUTION” before using this tool. Failure to following all instructions listed below may result in electric shock, fire, and/or serious personal injury.

SYMBOL MEANING

 **SAFETY ALERT SYMBOL:** Indicates DANGER, WARNING, OR CAUTION. May be used in conjunction with other symbols or pictographs.

 **DANGER:** Indicates an imminently hazardous situation, which, if not avoided, will result in death or serious injury.

 **WARNING:** Indicates a potentially hazardous situation, which, if not avoided, could result in death or serious injury.

 **CAUTION:** Indicates a potentially hazardous situation, which, if not avoided, could result in minor or moderate injury.

NOTICE: (Without Safety Alert Symbol) Indicates a situation that may result in property damage.



THIS SYMBOL DESIGNATES THAT THIS TOOL IS LISTED BY THE INTERTEK TESTING SERVICES, TO UNITED STATES AND CANADIAN STANDARDS

SAFETY INSTRUCTIONS

GENERAL SAFETY

Operating a Cordless Drill can be dangerous if safety and common sense are ignored. The user must be familiar with the operation of the tool. Read this manual to understand this Cordless Drill. **DO NOT** operate this Cordless Drill if you do not fully understand the limitations of this tool. **DO NOT** modify this Cordless Drill in any way.

BEFORE USING CORDLESS DRILL

WARNING:

To avoid serious injury and damage to the tool, read and follow all of the Safety and Operating Instructions before operating the Cordless Drill.

WARNING:

1. Some dust created by using power tools contains chemicals known to the State of California to cause cancer, birth defects, or other reproductive harm.

Some examples of these chemicals are:

- Lead from lead-based paints.
- Crystalline silica from bricks, cement, and other masonry products.
- Arsenic and chromium from chemically treated lumber.

Your risk from these exposures varies, depending on how often you do this type of work. To reduce your exposure to these chemicals: work in a well ventilated area and work with approved safety equipment, such as those dust masks that are specially designed to filter out microscopic particles.

2. **READ** the entire Owner's Manual. **LEARN** how to use the tool for its intended applications.

3. **GROUND ALL TOOLS.** If the tool is supplied with a 3-prong plug, it must be plugged into a 3-contact electrical receptacle. The 3rd prong is used to ground the tool and provide protection against accidental electric shock. **DO NOT** remove the 3rd prong.

4. **AVOID A DANGEROUS WORKING ENVIRONMENT.** **DO NOT** use electrical tools in a damp environment or expose them to rain.

5. **DO NOT** use electrical tools in the presence of flammable liquids or gasses.

6. **ALWAYS** keep the work area clean, well lit, and organized. **DO NOT** work in an environment with floor surfaces that are slippery from debris, grease, and wax.

7. **KEEP VISITORS AND CHILDREN AWAY.** **DO NOT** permit people to be in the immediate work area, especially when the electrical tool is operating.

8. **DO NOT FORCE THE TOOL** to perform an operation for which it was not designed. It will do a safer and higher quality job by only performing operations for which the tool was intended.

9. **WEAR PROPER CLOTHING.** **DO NOT** wear loose clothing, gloves, neckties, or jewelry. These items can get caught in the machine during operations and pull the operator into the moving parts. The user must wear a protective cover on their hair, if the hair is long, to prevent it from contacting any moving parts.

10. **CHILDPROOF THE WORKSHOP AREA** by removing switch keys, unplugging tools from the electrical receptacles, and using padlocks.

11. **ALWAYS UNPLUG THE TOOL FROM THE ELECTRICAL RECEPTACLE** when making adjustments, changing parts or performing any maintenance.

12. **KEEP PROTECTIVE GUARDS IN PLACE AND IN WORKING ORDER.**

13. **AVOID ACCIDENTAL STARTING.** Make sure that the power switch is in the "OFF" position before plugging in the power cord to the electrical receptacle.

SAFETY INSTRUCTIONS

14. REMOVE ALL MAINTENANCE TOOLS from the immediate area prior to turning "ON" the machine.

15. USE ONLY RECOMMENDED ACCESSORIES. Use of incorrect or improper accessories could cause serious injury to the operator and cause damage to the tool. If in doubt, check the instruction manual that comes with that particular accessory.

16. NEVER LEAVE A RUNNING TOOL UNATTENDED. Turn the power switch to the "OFF" position. **DO NOT** leave the tool until it has come to a complete stop.

17. DO NOT STAND ON A TOOL. Serious injury could result if the tool tips over, or you accidentally contact the tool.

18. DO NOT store anything above or near the tool where anyone might try to stand on the tool to reach it.

19. MAINTAIN YOUR BALANCE. DO NOT extend yourself over the tool. Wear oil resistant rubber soled shoes. Keep floor clear of debris, grease, and wax.

20. MAINTAIN TOOLS WITH CARE. Always keep tools clean and in good working order. Keep all blades and tool bits sharp, dress grinding wheels and change other abrasive accessories when worn.

21. EACH AND EVERY TIME, CHECK FOR DAMAGED PARTS PRIOR TO USING THE TOOL. Carefully check all guards to see that they operate properly, are not damaged, and perform their intended functions. Check for alignment, binding or breaking of moving parts. A guard or other part that is damaged should be immediately repaired or replaced.

22. DO NOT OPERATE TOOL WHILE TIRED, OR UNDER THE INFLUENCE OF DRUGS, MEDICATION OR ALCOHOL.

23. SECURE ALL WORK. Use clamps or jigs to secure the work piece. This is safer than attempting to hold the work piece with your hands.

24. STAY ALERT, WATCH WHAT YOU ARE DOING, AND USE COMMON SENSE WHEN OPERATING A POWER TOOL.

A moment of inattention while operating power tools may result in serious personal injury.

25. ALWAYS WEAR A DUST MASK TO PREVENT INHALING DANGEROUS DUST OR AIRBORNE PARTICLES, including wood dust, crystalline silica dust and asbestos dust.

Direct particles away from face and body.

Always operate tool in well ventilated area and provide for proper dust removal.

Use dust collection system wherever possible. Exposure to the dust may cause serious and permanent respiratory or other injury, including silicosis (a serious lung disease), cancer, and death.

Avoid breathing the dust, and avoid prolonged contact with dust. Allowing dust to get into your mouth or eyes, or lay on your skin may promote absorption of harmful material.

Always use properly fitting NIOSH/OSHA approved respiratory protection appropriate for the dust exposure, and wash exposed areas with soap and water.

26. USE A PROPER EXTENSION CORD IN GOOD CONDITION. When using an

extension cord, be sure to use one heavy enough to carry the current your product will draw. If in doubt, use the next heavier gauge.

The smaller the gauge number, the larger diameter of the extension cord. If in doubt of the proper size of an extension cord, use a shorter and thicker cord. An undersized cord will cause a drop in line voltage resulting in a loss of power and overheating.

USE ONLY A 3-WIRE EXTENSION CORD THAT HAS A 3-PRONG GROUNDING PLUG AND A 3-POLE RECEPTACLE THAT ACCEPTS THE TOOL'S PLUG.

SAFETY INSTRUCTIONS

SPECIFIC SAFETY INSTRUCTIONS FOR CORDLESS TOOLS

1. Cordless tools get their electrical power from batteries. They demand the same respect that corded tools demand. Cordless tools are very capable of causing injury if all safety precautions are not followed. Cordless tools come in many types; read and understand the section of this booklet for the type of cordless tool you are using, as well as the operator's manual provided with the tool.

2. Cordless tools may create sparks, so do not use them in an explosive atmosphere, near flammable liquids, gases or dust.

- To avoid accidental starting, remove batteries or lock off the switch when the tool is not being used, when changing accessories, and when adjusting or cleaning tools.
- Keep hands away from rotating or moving parts.
- Broken or abused battery packs can leak chemicals that can cause irritation or burns. If you come into contact with these chemicals, flush the area with water. If it contacts the eyes, flush with water and seek medical help.

3. Batteries may vent gas that can explode near a source of ignition, like a pilot light. Never use any cordless tool in the presence of open flame. Do not place battery packs near fire or heat. The battery packs could explode.

4. Choose the right battery pack for the tool. Use cordless tools only with their recommended battery packs. Other battery packs may create a risk of fire, burns, and explosions.

5. Charge battery pack safely.

- Charge battery packs only with their recommended chargers.
- 6. Charge in a dry location.
 - Do not charge near combustible materials.
 - Do not use a charger or battery pack if it has been hit, dropped or damaged.
 - Do not take apart the charger or battery pack. Take it to an authorized service center for all repairs.
 - Keep tools, battery packs and chargers out of the reach of children and people unfamiliar with the tools.

7. Maintain and store battery packs safely. Clean the contacts on the battery pack and tool with a pencil eraser if the tool isn't working at full power with a fully charged battery pack.

- Take the tool, charger, and battery to an authorized service center for all repairs. Do not attempt to repair them yourself.

Store battery packs away from other metal objects like paper clips, coins, keys, nails, screws, or other small metal objects. These things can make a connection from one terminal to the other, shorting the battery terminals together and causing burns or fire.

Store the battery pack away from extreme temperature conditions.

8. Disposing of Battery Packs:

Properly dispose of battery packs to help protect our environment. Battery pack chemistries can be dangerous to the environment under certain conditions. Recycle or dispose of properly. Refer to the instructions included with your battery pack for proper disposal/recycling of the battery packs. Local, state, or federal laws may prohibit disposal of certain batteries in ordinary trash.

- Place electrical tape over the battery pack's terminals before disposing/recycling.
- Do not incinerate a battery pack or throw it into fire even if it is damaged or is completely worn out. Battery packs can explode in a fire. Use the battery charger correctly
- Refer to the section of this manual relating to use of the battery charger before attempting to charge the battery.
- **DO NOT** attempt to use the charger with any batteries other than those supplied. Keep your battery charger clean; foreign objects or dirt may cause a short or block air vents. Failure to follow these instructions may cause overheating or fire
- If the supply cord is damaged, it must be replaced by the manufacturer, the service agent or similarly qualified persons in order to avoid a hazard

 **WARNING:** **DO NOT** attempt to recharge non-rechargeable batteries.

SAFETY INSTRUCTIONS

PERSONAL SAFETY

Prevent unintentional starting.

Ensure the switch is in the off-position before connecting to power source and/or battery pack, picking up or carrying the tool. Carrying power tools with your finger on the switch or energizing power tools that have the switch on invites accidents.

ALWAYS grip the tool firmly, DO NOT

overreach, and ensure you won't lose control. Keep secure footing while using a cordless drill.

Battery chargers are for indoors use only.

Ensure that the power supply and charger are protected against moisture at all times.

DO NOT FORCE THE TOOL to perform an operation for which it was not designed. It will do a safer and higher quality job by only performing operations for which the tool was intended.

Dress properly. Do not wear loose clothing or jewellery. Keep your hair, clothing and gloves away from moving parts. Loose clothes, jewellery or long hair can be caught in moving parts.

Use personal protective equipment. Always wear eye protection. Protective equipment such as dust mask, non-skid safety shoes, hard hat, or hearing protection used for appropriate conditions will reduce personal injuries.

WARNING: Always wear ear protection where the sound level exceeds 85dB and limit the time of exposure if necessary. If sound levels are uncomfortable, even with ear protection, stop using the tool immediately and check the ear protection is correctly fitted and provides the correct level of sound attenuation for the level of sound produced by your tool.

Remove battery pack from the power tool before making any adjustments, changing accessories, or storing power tools. Such preventive safety measures reduce the risk of starting the power tool accidentally.

Where possible, use clamps or a vice to hold your work and ensure that lighting is adequate.

WARNING: User exposure to tool vibration can result in loss of sense of touch, numbness, tingling and reduced ability to grip. Long term exposure can lead to a chronic condition. If necessary, limit the length of time exposed to vibration and use anti-vibration gloves.

Do not operate the tool with hands below a normal comfortable temperature, as vibration will have a greater effect. A poorly maintained, incorrectly assembled, or misused tool, may produce increased levels of noise and vibration. www.osha.gov provides information on sound and vibration levels in the workplace that may be useful to domestic users who use tools for long periods of time.

ADDITIONAL INFORMATION regarding the safe and proper operation of this product is available from:

- Power Tool Institute
1300 Summer Avenue
Cleveland, OH 44115-2851
www.powertoolinstitute.org
- National Safety Council
1121 Spring Lake Drive
Itasca, IL 60143-3201
www.nsc.org
- American National Standards Institute
25 West 43rd Street, 4th Floor
New York, NY 10036
www.ansi.org
- ANSI 01.1 Safety Requirements for
Woodworking Machines and the
U.S. Department of Labor regulations
www.osha.gov

SAVE THESE INSTRUCTIONS. Refer to them frequently and use them to instruct others.

SPECIFICATIONS

CHUCK:

LOCKING TYPE.....1/4" Hex Shank

MOTOR:

DRILL MOTOR VOLTAGE.....12v DC

NO LOAD SPEED.....0-500 RPM

TORQUE.....885 IN-LBS (100Nm)

BATTERY:

CELL TYPE Li-Ion

VOLTAGE12v DC

RUN CAPACITY.....2.0Ah

CHARGER:

INPUT POWER (US/CAN)110-120VAC /60Hz /30W

OUTPUT POWER (US/CAN)..... 12v DC/ 540 mA

CHARGE TIME 1h

CORD LENGTH5FT

PERFORMANCE:

IMPACT RATE (P/MIN)..... 0-3000IPM

SOUND RATING (NO LOAD)83dB

SOUND RATING (LOAD)94dB

WEIGHT (w/BATTERY).....2 lbs.

NOTE: The specifications, photographs, drawings and information in this manual represent the model when the manual was prepared. Changes and improvements may be made at any time, with no obligation on the part of Rikon Power Tools to modify previously delivered units. Reasonable care has been taken to ensure that the information in this manual is correct, to provide you with the guidelines for the proper safety, assembly and operation of this machine.

OVERVIEW



31-121 12v IMPACT DRIVER OVERVIEW

- | | |
|-------------------------|---------------------------------|
| A. Chuck Locking Collar | F. Motor Cooling Vents |
| B. 1/4" Hex Chuck | G. LED Battery Level Indicators |
| C. LED Light | H. FWD/REV Switch |
| D. Trigger Switch | I. Rubber Palm Grip |
| E. Rubber Finger Grip | J. 12V Battery |

NOTE: Full Parts Explosion and Parts List are listed on pages 14 and 15.

INSTRUCTIONS

Intended Use

Battery-operated impact driver with high levels of torque suitable for medium duty tasks such as driving screws, nuts, bolts and other fasteners.

Unpacking Your Impact Driver

- Carefully unpack and inspect your product. Fully familiarise yourself with all its features and functions
- Ensure all parts of the product are present and in good condition. If any parts are missing or damaged, have such parts replaced before attempting to use this product

Before Use

IMPORTANT: Your impact driver's battery comes partly charged. It is recommended that you fully charge the battery before using the tool for the first time. It is also recommended that you fully drain then fully charge the battery for a further 2 times to condition the battery, ensuring optimal usage is achieved for the duration of the battery life.

Charging the Battery

⚠ WARNING: ONLY use this charger to charge the supplied battery or additional purchased batteries that are specifically designed for this tool.

⚠ WARNING: The Battery Charger is designed for indoor use only and MUST NOT be used in damp or wet conditions.

⚠ WARNING: Failure to follow the correct procedure when charging batteries will result in permanent damage.

Note: Fully charging the battery can take 1–3hrs, depending on how depleted the battery charge is when inserting the battery into the charger. Also, it may take longer if the battery has been in a discharged state for an extended period of time.

1. Plug in the Power Cord.
2. Insert the Battery into the Battery Charger (it can only fit one way).
3. The Red LED will illuminate, which indicates charging.
4. The Green LED will illuminate once the battery is fully charged

Installing a Driver Bit

Note: Items referenced below and throughout the manual (A thru J) can be found in the "OVERVIEW" section of the manual found on page nine.

1. Pull the Chuck Locking Collar (A) of the 1/4" Hex Chuck (B) forward and insert the bit.
2. Release the Collar.
3. Pull on the bit to check that it is securely installed. If the bit is not secure, repeat steps 1 and 2.

Note: Make sure screwdriver bits used are hardened and suitable for use with an impact driver.

Installing the Battery into Drill

1. Ensure the Battery (J) has adequate charge (see 'Charging the Battery').
2. Insert the Battery into the below the Hand Grip (E & I) (the Battery can only fit one way) until the Battery locks into place with a faint clicking sound.
3. Your impact driver is ready for use.
4. Select Forward or Reverse (H) and test the drill by depressing the Trigger Switch (D).

Removing the Battery

1. Press in and hold the Battery Release clips on both sides of the Battery (J) then pull down to remove the Battery.
2. The Battery can now be inserted into the Battery Charger to charge, if required (see 'Charging the Battery') or stored in a cool, dry place.

INSTRUCTIONS

Direction/Rotation of Driver Bit

⚠ WARNING: The rotational direction of the bit cannot be changed while the impact drill is running. **DO NOT** attempt to change the rotational direction while the impact driver is running as this may cause permanent damage to the tool.

- Use the Forward/Reverse Switch (D) to change the direction of the bit rotation.
- For counter-clockwise rotation, push the switch to the right.
- For clockwise rotation, push the switch to the left

Note: When the Forward/Reverse Switch is in the central position, the impact driver is locked and cannot be switched 'ON'. Use this setting as a safety feature to prevent the impact driver from being switched 'ON' accidentally, especially during storage and transportation.

Switching ON & OFF

⚠ WARNING: **ALWAYS** wear adequate personal protective equipment when setting up and operating this machine.

1. To start the impact driver, depress the Trigger Switch (D).
2. The built-in LED Work Light (C) will illuminate when the Trigger Switch is depressed.
Note: If the Trigger Switch cannot be pressed down, check that the Forward/Reverse Switch (H) is not set to its middle position, which locks the device (see '**Direction/Rotation of Driver Bit**').
3. The speed of the impact driver is controlled by the movement of the trigger: the more the Trigger Switch is pressed down, the faster the impact driver will run.
4. Release the Trigger Switch to stop the tool.

⚠ WARNING: If the power tool gets excessively hot in use, stop using the tool immediately and allow to cool before continuing work. The cooling period can be reduced by operating the impact driver at maximum speed with no load. Always make sure the Motor Vents (F) are not blocked and do not allow dust to enter the body of the tool through the Motor Vents; dust, especially metallic dust, may damage or the tool.

Maintenance

⚠ WARNING: Before carrying out any maintenance/cleaning of the Battery Charger **ALWAYS** disconnect from the power source. Remove the battery before carrying out any maintenance/cleaning of the impact driver.

Note: The charger contains no user-serviceable parts. If the device does not perform as outlined in this manual, contact Technical Support.

- Regularly check that all the fixing screws are tight.
- Inspect the supply cord of the tool, prior to each use, for damage or wear.

Cleaning

- Keep your tool clean at all times. Dirt and dust will cause internal parts to wear quickly, and shorten the machine's service life. Clean the body of your machine with a soft brush, or dry cloth.

If available, use clean, dry, compressed air to blow through the ventilation holes.

- Clean the tool casing with a soft damp cloth using a mild detergent. Do not use alcohol, gasoline or strong cleaning agents
- Never use caustic agents to clean plastic parts

Lubrication

- Slightly lubricate the Chuck Locking Collar at regular intervals with a suitable spray lubricant.

WARRANTY

RIKON **POWER TOOLS®**

2-Year Limited Warranty

RIKON Power Tools Inc. ("Seller") warrants to only the original retail consumer/purchaser of our products that each product be free from defects in materials and workmanship for a period of two (2) years from the date the product was purchased at retail. This warranty may not be transferred.

This warranty does not apply to defects due directly or indirectly to misuse, abuse, negligence, accidents, repairs, alterations, lack of maintenance or normal wear and tear. Under no circumstances will Seller be liable for incidental or consequential damages resulting from defective products. All other warranties, expressed or implied, whether of merchantability, fitness for purpose, or otherwise are expressly disclaimed by Seller. This warranty also covers products used for commercial, industrial or educational purposes. The warranty for these claims will be limited to a one-year period.

This limited warranty does not apply to accessory items such as blades, drill bits, sanding discs, grinding wheels, guide bearings, belts and other related items.

Seller shall in no event be liable for death, injuries to persons or property, or for incidental, contingent, special, or consequential damages arising from the use of our products.

To take advantage of this warranty proof of purchase documentation, which includes date of purchase and an explanation of the complaint, must be provided.

The Seller reserves the right to effect at any time, without prior notice, those alterations to parts, fittings, and accessory equipment which they may deem necessary for any reason

To register your machine online, visit RIKON at www.rikontools.com/warranty

To take advantage of this warranty, or if you have any questions, please contact us at 877-884-6167 or email warranty@rikontools.com

PARTS DIAGRAM

31-121 1/4" IMPACT DRIVER

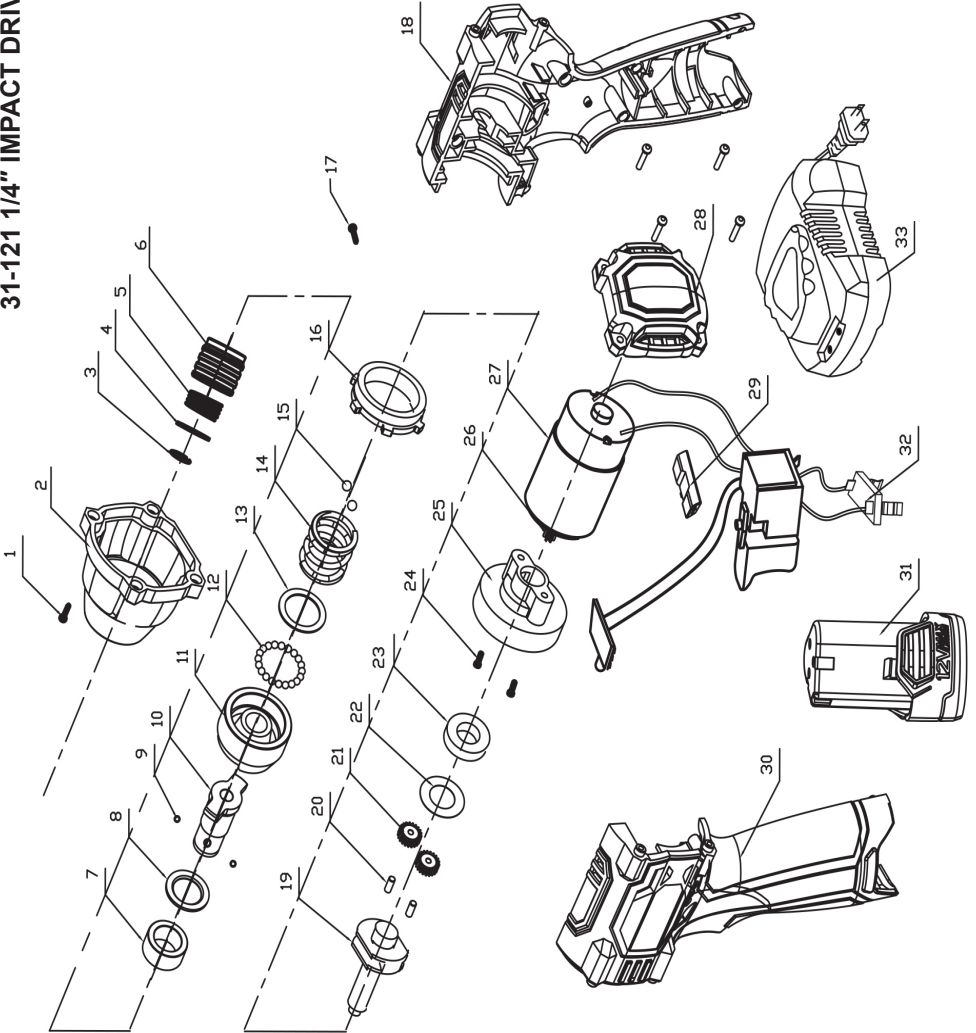

PARTS LIST

KEY NO.	DESCRIPTION	QTY	MFG. PART NO.
1	Screw	8	P31-121-1
2	Gear Housing	1	P31-121-2
3	Retaining Ring	1	P31-121-3
4	Facing	1	P31-121-4
5	Spring	1	P31-121-5
6	Bushing	1	P31-121-6
7	Shaft Sleeve	1	P31-121-7
8	Washer	1	P31-121-8
9	Steel Ball 3mm	2	P31-121-9
10	Spindle	1	P31-121-10
11	Impact Block	1	P31-121-11
12	Steel Ball 4mm	19	P31-121-12
13	Washer	1	P31-121-13
14	Impact Spring	1	P31-121-14
15	Steel Ball 4.76mm	2	P31-121-15
16	Annular Gear	1	P31-121-16
17	Screw	4	P31-121-17
18	Right Housing	1	P31-121-18
19	Drive Shaft	1	P31-121-19
20	Pin	2	P31-121-20
21	Planet Gear	2	P31-121-21
22	Washer	1	P31-121-22
23	Bearing	1	P31-121-23
24	Screw	2	P31-121-24
25	Gear Box	1	P31-121-25
26	Motor Gear	1	P31-121-26
27	Motor	1	P31-121-27
28	Rear Cowl	1	P31-121-28
29	FWD/REV Button	1	P31-121-29
30	Left Housing	1	P31-121-30
31	12v Battery	1	P31-121-31
32	Switch Assembly	1	P31-121-32
33	Charger 120v	1	P31-121-33

NOTE: Please reference the Manufacturer's Part Number when calling for Replacement Parts.

For Parts under Warranty, proof and date of purchase are required.



For more information:
16 Progress Road
Billerica, MA 01821

877-884-5167 / 978-528-5380
techsupport@rikontools.com
parts@rikontools.com