

EXCALIBUR LEVEL AND STAIR RAIL DETAILS

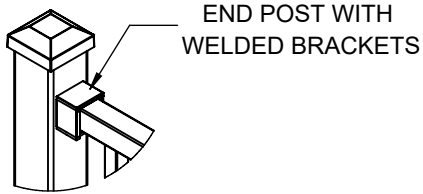

NOTES:
POST INCLUDES BRACKET
COVERS TO HIDE FASTENERS

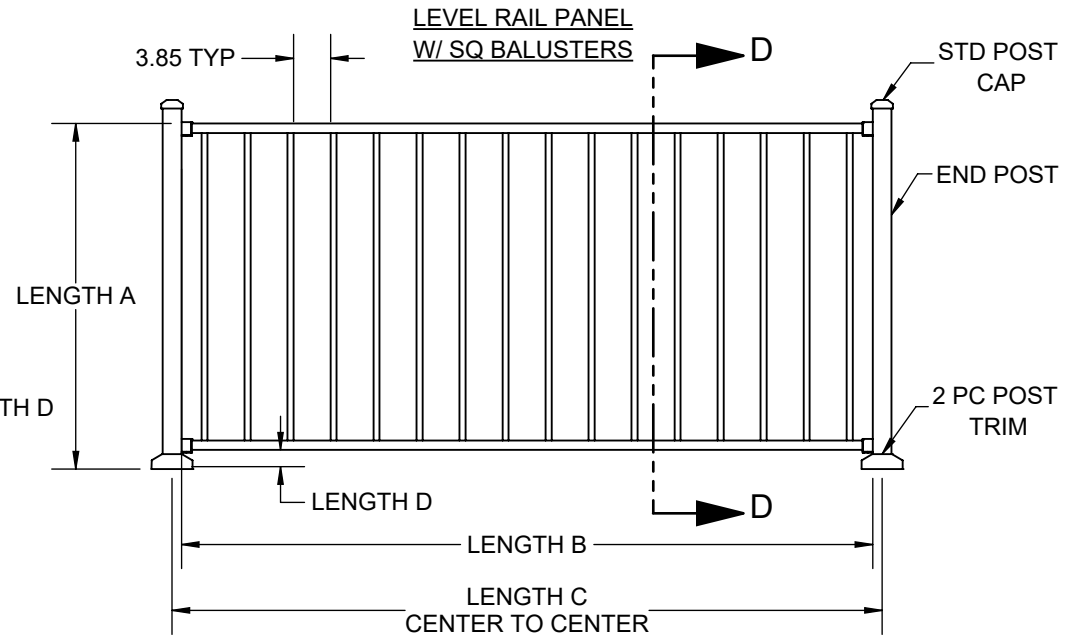
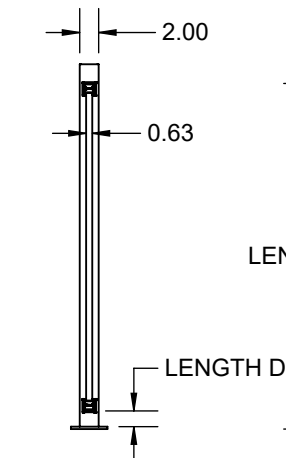

NOTE:
(A) FINISHED RAIL HEIGHT = 36", 38", 42"
(B) PANEL LENGTH = 71.75", 95.75", 119.75"
(C) MAX SPAN = 96.00" X 42 IBC, 96.00" X 36 IRC
(D) BOTTOM SPACE = 1.75", 3.75"

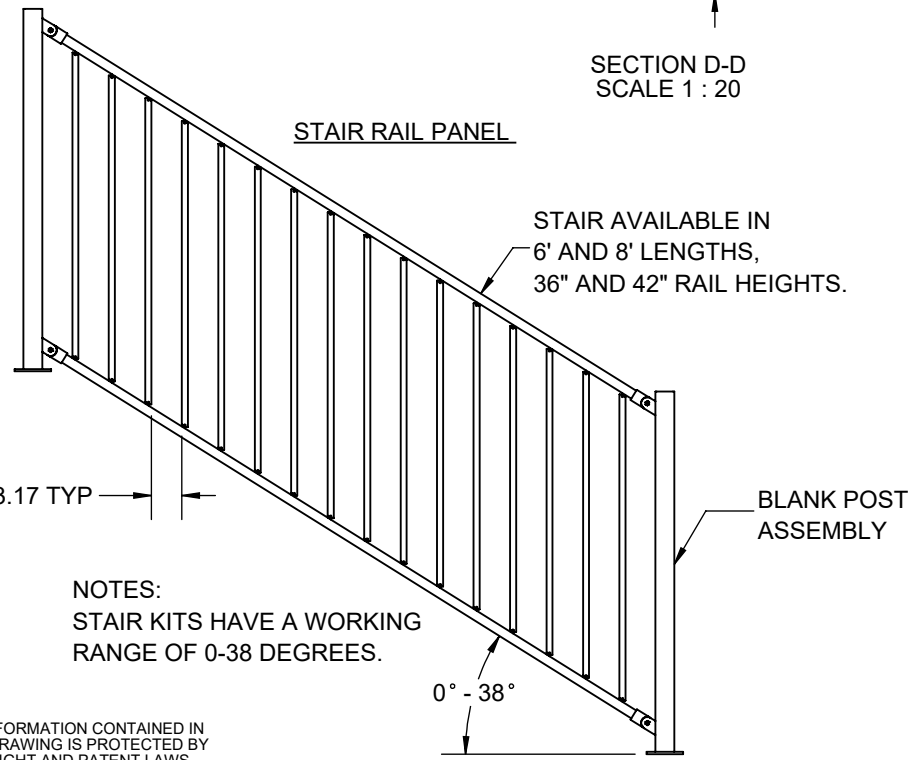

NOTES:
STAIR KITS HAVE A WORKING
RANGE OF 0-38 DEGREES.

THE INFORMATION CONTAINED IN THIS DRAWING IS PROTECTED BY COPYRIGHT AND PATENT LAWS OF THE UNITED STATES AND OTHER COUNTRIES. ANY REPRODUCTION IN PART OR AS A WHOLE WITHOUT WRITTEN PERMISSION IS PROHIBITED.

REV	BY	DATE	PCR	DESCRIPTION

TOLERANCES		BARRETTE Outdoor Living	
FRACTION	±1/16	DRAWN: RP	DATE: 02/21/2018
XX	±0.01	APPROVED:	
XXX	±0.005	DESCRIPTION: EXCALIBUR LEVEL AND STAIR RAIL	
ANGLE	±1.0°	SHEET 1 OF 5	
FINISH	125 RMS	SCALE: NTS	
UNLESS OTHERWISE SPECIFIED		WEIGHT: N/A	
		REVISION	PART NUMBER
		0	N/A

DECORATIVE PANEL

SERPENTINE
71.75"x34"

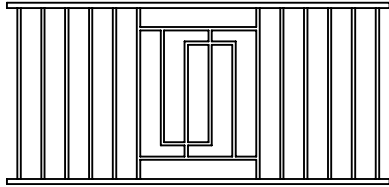

SERPENTINE
71.75"x40"

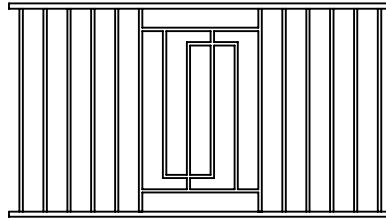

MOSAIC
71.75"x34"

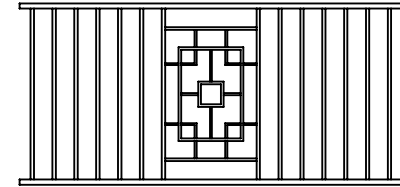

SERPENTINE
95.75"x34"

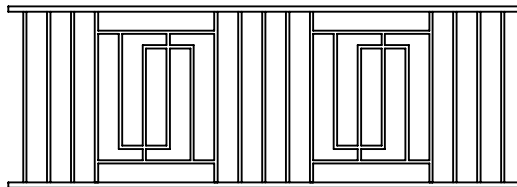

SERPENTINE
95.75"x40"

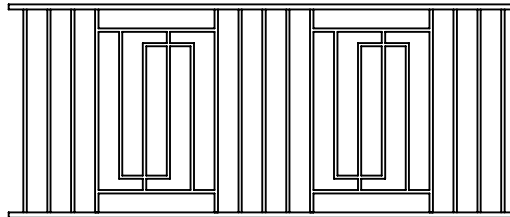

MOSAIC
95.75"x34"

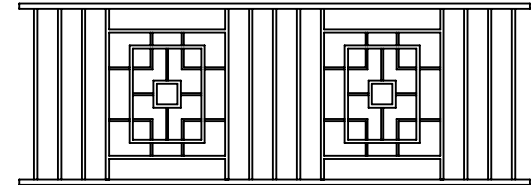

MOSAIC
71.75"x40"

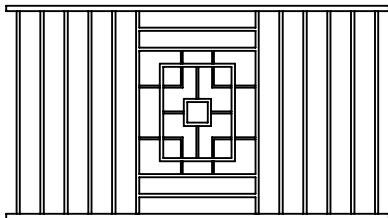

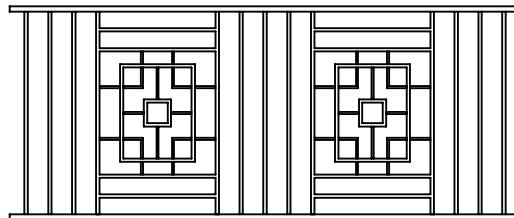

MOSAIC
71.75"x40"



THE INFORMATION CONTAINED IN THIS DRAWING IS PROTECTED BY COPYRIGHT AND PATENT LAWS OF THE UNITED STATES AND OTHER COUNTRIES. ANY REPRODUCTION IN PART OR AS A WHOLE WITHOUT WRITTEN PERMISSION IS PROHIBITED.

REV	BY	DATE	PCR	DESCRIPTION

TOLERANCES	
FRACTION	±1/16
XX	±0.01
XXX	±0.005
ANGLE	±1.0°
FINISH	125 RMS
UNLESS OTHERWISE SPECIFIED	

		BARRETTE Outdoor Living	
DRAWN:	RP	DATE:	02/21/2018
DESCRIPTION:		DECORATIVE PANELS	
SHEET 2 OF 5	REVISION	PART NUMBER	
SCALE 1:36			
WEIGHT: 41.53			

EXCALIBUR COMPONENT DETAILS

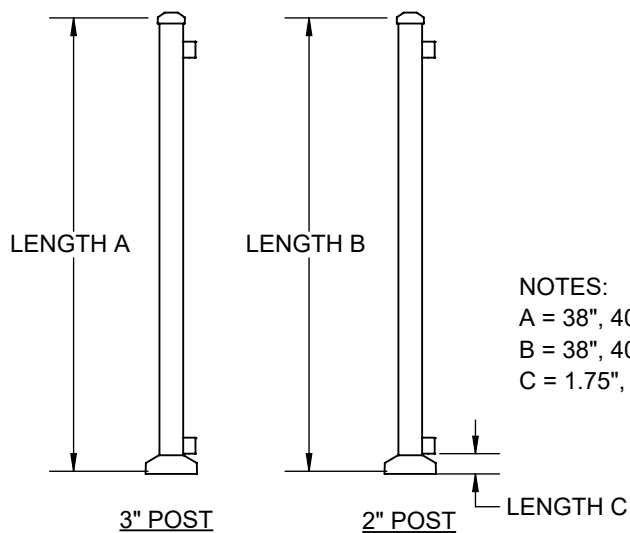

NOTES:
 A = 38", 40", 46"
 B = 38", 40", 44", 46", 48"
 C = 1.75", 3.75"

END POST

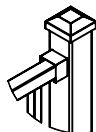

CORNER POST

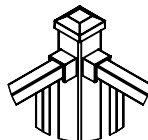

LINE POST

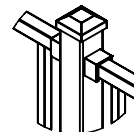

BLANK POST

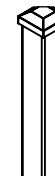

FASCIA POST



NOTE: BRACKET KITS INCLUDE (EXCEPT BLANK AND FASCIA POST), POST TOP, BRACKET COVERS, TRIM RING, VINYL SHIMS, HEX HEAD MOUNTING SCREWS AND HEX BIT FOR ATACHEMNTN TO STEEL OR WOOD POST.

SCROLLWORK DECORATIVE LEVEL BRACKET

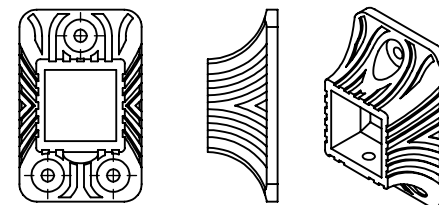

IMPERIAL DECORATIVE LEVEL BRACKET

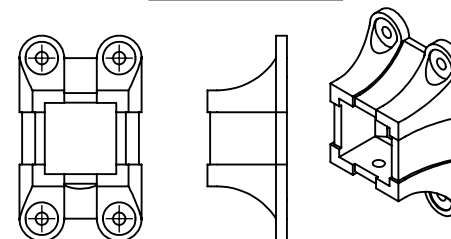

FASCIA POST

FRONT VIEW

SIDE VIEW

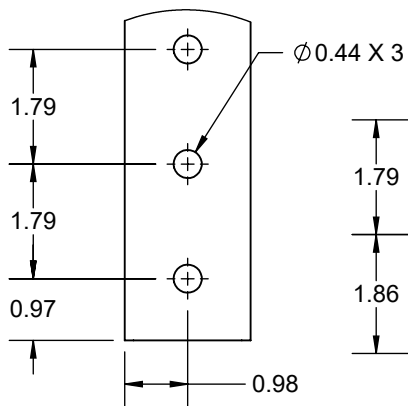
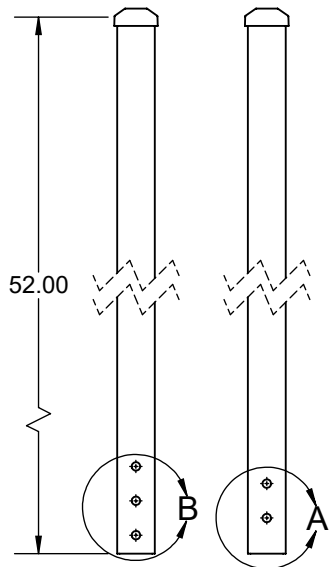

DETAIL B
SCALE 1 : 3

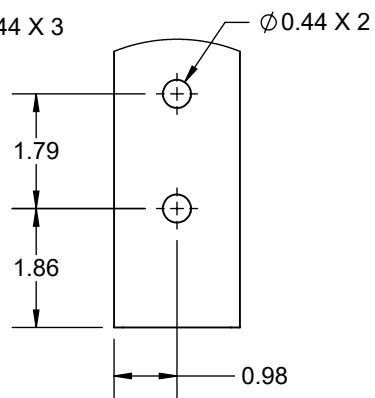

DETAIL A
SCALE 1 : 3

THE INFORMATION CONTAINED IN THIS DRAWING IS PROTECTED BY COPYRIGHT AND PATENT LAWS OF THE UNITED STATES AND OTHER COUNTRIES. ANY REPRODUCTION IN PART OR AS A WHOLE WITHOUT WRITTEN PERMISSION IS PROHIBITED.

REV	BY	DATE	PCR	DESCRIPTION

TOLERANCES	
FRACTION	±1/16
XX	±0.01
XXX	±0.005
ANGLE	±1.0°
FINISH	125 RMS
UNLESS OTHERWISE SPECIFIED	

		BARRETTE Outdoor Living	
DRAWN:	RP	DATE:	02/21/2018
DESCRIPTION: EXCALIBUR COMPONENT DETAILS			
SHEET 3 OF 5	REVISION	PART NUMBER	
SCALE 1:16	0	N/A	
WEIGHT: N/A			

EXCALIBUR COMPONENT DETAILS

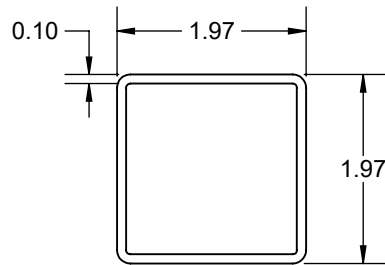

2" POST

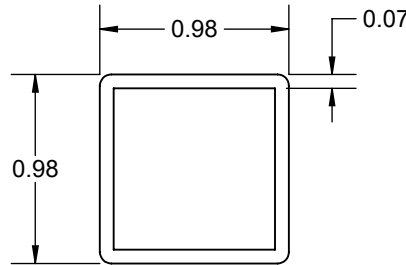

TOP / BTM RAIL

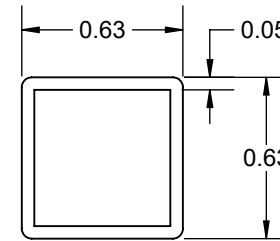

SQ BALUSTER

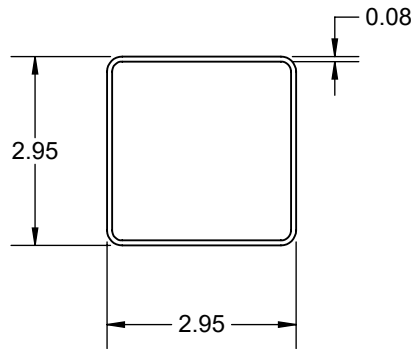

3" POST

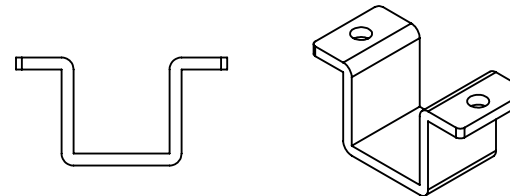

FLUSH MOUNT BRKT

NOTE:
1. FLUSH BRKT USED TO ATTACH WOOD/DECK BOARD. FASTENERS ARE INCLUDED.

THE INFORMATION CONTAINED IN THIS DRAWING IS PROTECTED BY COPYRIGHT AND PATENT LAWS OF THE UNITED STATES AND OTHER COUNTRIES. ANY REPRODUCTION IN PART OR AS A WHOLE WITHOUT WRITTEN PERMISSION IS PROHIBITED.

REV	BY	DATE	PCR	DESCRIPTION

TOLERANCES		BARRETTE Outdoor Living	
FRACTION	±1/16	DRAWN: RP	DATE: 02/21/2018
XX	±0.01	APPROVED: _____	
XXX	±0.005	EXCALIBUR COMPONENT DETAILS	
ANGLE	±1.0°	SHEET 4 OF 5	
FINISH	125 RMS	SCALE 1:2	
UNLESS OTHERWISE SPECIFIED		REVISION 0	PART NUMBER N/A
		WEIGHT: N/A	

EXCALIBUR POST MOUNT CONNECTIONS

FASCIA BRACKET

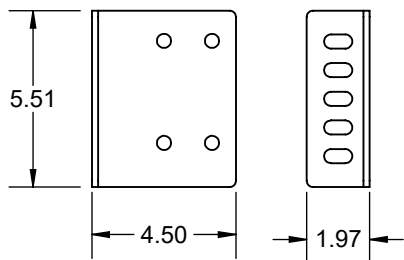

IN LINE POST

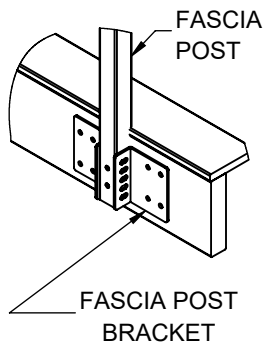

INSIDE CORNER MOUNT

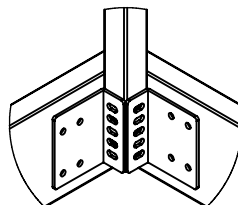

OUTSIDE CORNER MOUNT

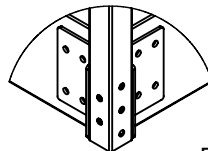

POST DETAILS WITH BOTTOM PLATE

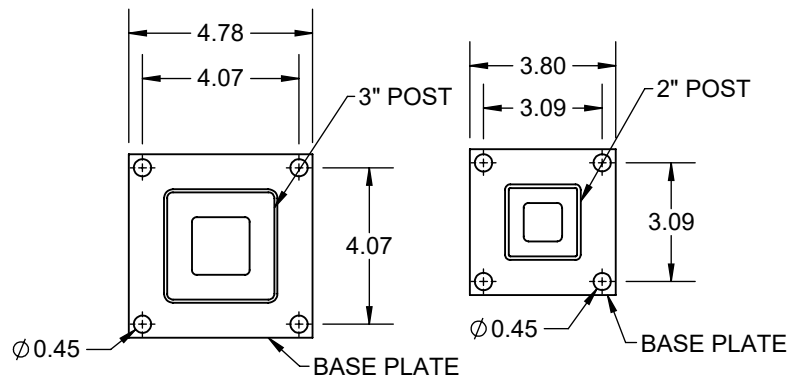

NOTE:
BRACKETS ARE NOT INCLUDED WITH FASCIA POST. THEY WILL NEED TO BE BOUGHT AND INSTALLED SEPERATELY.

POST BASE CONNECTIONS INTO WOOD WITH THRU BOLTS

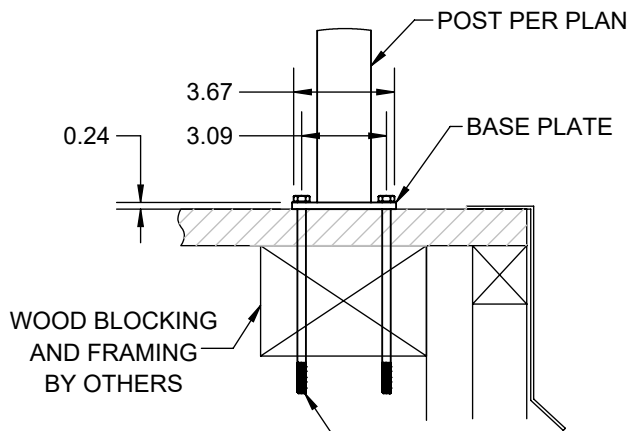

USE 3/8" DIAMETER THROUGH BOLTS (MINIMUM LENGTH 5") INTO WOOD MEMBERS WITH MINIMUM EMBEDMENT DEPTH OF 4' INTO SOLID WOOD.

- NOTE:**
1. COMMERCIAL APPLICATIONS ARE ALWAYS BOLTED, USE 3/8" DIAMETER A307 THROUGH BOLTS INTO SOLID WOOD BLOCKING.
 2. WOOD BLOCKING BY OTHERS.
 3. BLOCKING MUST BE DESIGNED TO WITHSTAND PROPER LOADING.

POST BASE CONNECTION INTO CONCRETE WITH WEDGE ANCHORS

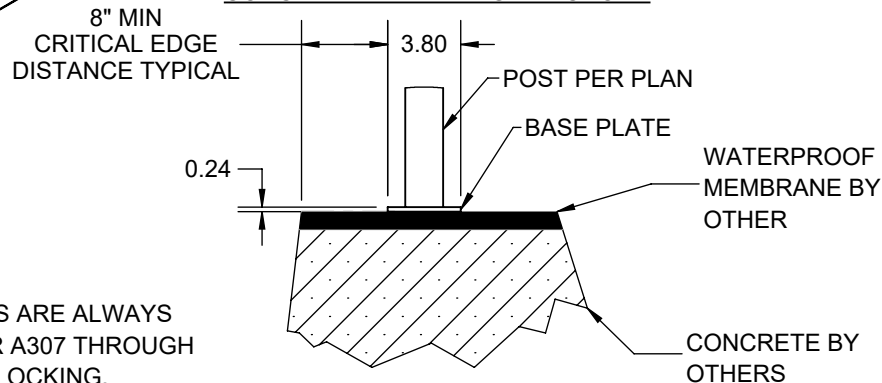

NOTE:
USE 4-3/8"x7" LONG WEDGE ANCHORS USE SIMPSON SET EPOXY INTO CONCRETE WITH 5" EMBEDMENT DEPTH

THE INFORMATION CONTAINED IN THIS DRAWING IS PROTECTED BY COPYRIGHT AND PATENT LAWS OF THE UNITED STATES AND OTHER COUNTRIES. ANY REPRODUCTION IN PART OR AS A WHOLE WITHOUT WRITTEN PERMISSION IS PROHIBITED.

REV	BY	DATE	PCR	DESCRIPTION

TOLERANCES	
FRACTION	±1/16
XX	±0.01
XXX	±0.005
ANGLE	±1.0°
FINISH	125 RMS
UNLESS OTHERWISE SPECIFIED	

		BARRETTE Outdoor Living	
DRAWN: RP	DATE: 02/21/2018	APPROVED:	
DESCRIPTION: EXCALIBUR POST MOUNT DETAIL			
SHEET 5 OF 5	REVISION	PART NUMBER	
SCALE 1:6	0	N/A	
WEIGHT: N/A			