

# Shingle Underlayments and Flintlastic® SA Roof Systems

# 5

*YOUR OBJECTIVE:*

*To learn the differences between the various underlayments available.*

*To learn when a particular type of underlayment is the best choice for a particular situation, and to learn how to correctly install the different types of underlayments and Flintlastic® Self-Adhered roof systems.*

There are two major types of shingle underlayment: water-resistant and waterproof. Within these types are many variations both between brands and within brands.

## UNDERLAYMENT SPECIFICATIONS

### WATER RESISTANT UNDERLAYMENT

Two common grades of water resistant shingle underlayment are available; #15, also known as standard shingle underlayment, and #30, also known as heavy duty shingle underlayment. However, within those grades there are many choices. For example, among standard shingle underlayment (#15), the following can be found:

- ◆ **UNRATED SHINGLE UNDERLAYMENT.** Generally the lowest priced and having the most unpredictable levels of asphalt saturation. Quality may vary from batch to batch.
- ◆ **ASTM D 4869 (TYPE 1).** All ASTM rated materials should be superior to “unrated” underlayment. However, an ASTM rating is not enforced by any independent organization. This rating is the “standard” specification for asphalt saturated organic felt shingle underlayment used in roofing.” It covers standard #15 shingle underlayment, also known as “Type 15” or “Type 1.” Because of a higher saturation level this product should not be subject to serious wrinkling. CertainTeed ShingleFelt 15 & 30 and RoofWrap 15 fall into this category.
- ◆ **ASTM D6757 HIGH PERFORMANCE SHINGLE UNDERLAYMENT.** CertainTeed Roofers’ Select™ is an organic felt reinforced with fiber glass fibers. Roofers’ Select is thoroughly saturated with asphalt, demonstrates a higher resistance to tearing than does any other #15 type underlayment and it is very resistant to wrinkling. It carries a UL classification, meets the ASTM D6757 standards and all performance requirements of ASTM D4869 and ASTM D226.

There is also a wide selection among heavy duty underlayment products:

- ◆ **UNRATED HEAVY DUTY SHINGLE UNDERLAYMENT (#30).** These heavy duty products are built using a heavier weight of organic felt; however, as mentioned above, unrated products are subject to wide variation in saturation. Under-saturated underlayments are subject to severe wrinkling. Under-saturated #30 underlayment has been known to wrinkle even after shingles are installed, telegraphing the wrinkles through the installed shingles after the job is finished.
- ◆ **ASTM D4869 (TYPE II).** A more predictable quality of heavy duty underlayment, much more resistant to wrinkling. CertainTeed RoofWrap 30 meets this standard.
- ◆ **ASTM D226 (NONPERFORATED).** This is a heavier felt normally used in built-up roofing systems. These felts have a greater asphalt content and exhibit superior strength and resistance to wrinkling. Both RoofWrap 15 and 30 meet this standard.
- ◆ **SYNTHETIC UNDERLAYMENT.** There are a variety of these underlayments made from different synthetic components, all are light-weight and claim superior resistance to tearing and wrinkling. Most of these type underlayments carry one or more performance or approval ratings. CertainTeed will not void or reduce their Asphalt Shingle Warranty when their shingles are installed over these types of “rated synthetic underlayments” (i.e. meets one or more of the ASTM performance standards above, or has one or more industry recognized code-body approval).
  - CertainTeed DiamondDeck™ is a synthetic, scrim-reinforced, water-resistant underlayment that can be used beneath shingle, shake, metal or slate roofing. It has exceptional dimensional stability compared to standard felt underlayment. DiamondDeck’s special top surface treatment provides excellent slip resistance, even when wet.

### WATERPROOFING SHINGLE UNDERLAYMENT

Waterproofing Shingle Underlayment (WSU) is a very different kind of material. It is used in vulnerable locations on the roof deck that are most likely to leak during storms with high winds or when ice dams develop. Along the eaves, around roof penetrations and in the valleys are the areas most likely to require waterproof underlayment.

### WHEN UNDERLAYMENTS ARE REQUIRED

The installation of water-resistant underlayment beneath shingles is **required** by many shingle manufacturers. Generally, CertainTeed recommends that underlayment be installed but does not require it except as noted below.

---

## WATER-RESISTANT UNDERLAYMENTS

---

**LOW SLOPE:** All roof shingles applied to a low slope deck (2" to below 4" per foot) require the use of CertainTeed WinterGuard™ Waterproofing Shingle Underlayment, or its equivalent,\* applied over the entire deck surface. Consult the WinterGuard and individual shingle application instructions for details.

\* For low slopes, underlayment equivalents to WinterGuard include:

- 1) waterproofing shingle underlayments meeting ASTM D1970; and
- 2) two layers of 36" (915 mm) wide felt shingle underlayment lapped 19" (485 mm). Shingle underlayment should meet ASTM D6757, ASTM D4869 Type I or ASTM D226 Type I (except when applying LandMark TL or Presidential TL Shake shingles).

Because water drains slowly from these slopes, there is a greater chance of water back-up and damage from ice-dams. The application instructions for each CertainTeed roofing product indicate the minimum slope below which the product must not be applied, and a range of slopes where "low slope" application instructions must be followed. These instructions call for the use of a waterproofing shingle underlayment, such as CertainTeed WinterGuard™ Waterproofing Shingle Underlayment, or its equivalent. **However, careful consideration of local weather and the use of a waterproof underlayment meeting ASTM D 1970 are thought to be a good practice** by CertainTeed. Follow the application instructions for the particular shingle. Note the special low slope application requirements for the two products below:

- ◆ **LANDMARK TL AND PRESIDENTIAL TL SHINGLES:** Low slope application requires a layer of WinterGuard or an equivalent product over the entire roof deck. A **double layer of asphalt felt underlayment is not an acceptable alternative** when applying these products.

**COLD WEATHER CLIMATES (ALL SLOPES):** Application of WinterGuard or its equivalent is strongly recommended whenever there is a possibility of ice build-up. Follow manufacturer's application instructions.

**VALLEY FLASHING:** Line valley by centering 36" (915 mm) wide CertainTeed WinterGuard, or equivalent,\*\* in the valley and applying directly to deck. Consult the WinterGuard and individual shingle application instructions for details.

\*\*\* For valley liner, the equivalents to WinterGuard include:

- 1) waterproofing shingle underlayments meeting ASTM D1970;
- 2) one layer of 50 lb. or heavier asphalt coated roll roofing; 3) one layer of mineral-surfaced roll roofing; and 4) two layers of 36" (915 mm) wide felt shingle underlayment. Coated roll roofing should meet ASTM D224; shingle underlayment should meet ASTM D6757, ASTM D4869 or ASTM D226.

### REQUIREMENTS BY UNDERWRITERS LABORATORIES (UL) FOR FIRE-RATED PREPARED ROOFING

- ◆ UL classified underlayment is required under Class A fire-resistant shingles when plywood or non-veneer (OSB, WB, etc.) APA sheathing is at least  $\frac{3}{8}$ " thick but less than  $\frac{15}{32}$ ".
- ◆ When sheathing thicker than  $\frac{15}{32}$ " is used under fiber glass-type shingles, shingle underlayment is not required for a UL Class A fire rating.

Water resistant underlayment is a product that consists of organic felt impregnated with asphalt saturant. Some water-resistant underlayments, such as CertainTeed's Roofers' Select, also contain a fiber glass reinforcement which increases tear strength and reduces wrinkling.

Water-resistant underlayment was originally invented to keep the roof decking dry until shingles could be applied. Applying this underlayment was originally called "drying-in the roof." It was also useful as a separation sheet between the roof sheathing boards (before OSB and plywood sheets were used as roof decking) and the asphalt shingles. This was important because resin pockets in the pine planks caused the asphalt to degrade prematurely unless the underlayment separated the resin and asphalt from each other.

Water-resistant underlayment is made to shed most of the water that falls on it unless it is torn or punctured. Its ability to be water-resistant is temporary. As the sun degrades the exposed asphalt the materials begin to dry, absorb more moisture, lose its strength and eventually begin to tear. The less asphalt used to saturate the underlayment sheet during manufacturing, the shorter its life. Since asphalt is the most expensive component of shingle underlayment, lower priced materials will have less asphalt and a shorter life when exposed to the sun. Lower priced shingle underlayment, for the same reason, is also subject to severe wrinkling when it gets wet or even just damp.

Underlayment is used under asphalt shingles for a variety of reasons, such as providing:

- ◆ Backup for water-shedding protection of the deck if shingles fail from wind-driven rain. The lower the slope, the more important underlayment is, since water flows more easily under shingles on low slopes.
- ◆ A protective barrier to the elements between the time the old shingles have been torn off and prior to the new shingle being applied. However, the underlayment should not be relied on as a temporary roof system, especially when the drip edge flashing is not yet in place. It is unlikely to prevent leaking in the event of heavy wind and rain.
- ◆ An agent to hide minor imperfections of the decking material and reduce "picture framing" of deck panels.
- ◆ Fire ratings (Class A) when used in conjunction with shingles.

---

## INSTALLATION GUIDELINES FOR WATER-RESISTANT UNDERLAYMENTS

---

The following is a general guide for the installation of water-resistant shingle underlayment. These guidelines can be used regardless of the weight of the underlayment. However, always be sure to consider the local codes.

### OVERNIGHT EXPOSURE

If underlayment has been exposed overnight, moisture from dew should be allowed to completely dry before shingling over. If this does not happen, the moisture will become trapped beneath the shingles. Wrinkling can telegraph through the shingle and make a good shingle job look terrible. The worse part is that the job can look good when you leave in the evening but the wrinkles can reappear the next morning when the homeowner will notice them.

## Here Are Some Tips...

For roof pitches above 7:12 consider adding a third row of fasteners, making each row 9" apart instead of 12" apart.

Dennis Torback from Fulton, KS tells us: "I always use Plasti Top nails on felt, it resists tearing under foot and has held up during an unexpected storm with high winds."

While we've discussed underlayment being exposed overnight, it is suggested that whenever possible the roofing contractor only tear off what he can shingle over that same day. This prevents the most common underlayment installation problems.

### APPLYING UNDERLAYMENT BETWEEN SHINGLE LAYERS

CertainTeed advises against applying underlayment over existing roofing. The underlayment may cover or create soft areas in the roof surface. These soft spots can cause shingle fasteners to be under- or over-driven, thereby weakening the shingle hold-down strength (potential blow-offs) or tearing holes in the shingles that can allow water intrusion (potential leaks). Underlayment applied over existing roofing interferes with the ability to nest the new shingles into the old. Nesting is an accepted and time-proven method of applying same-size new shingles over old ones.

So, if the old shingles are to be left in place and the new shingles can be nested into the old, then no additional underlayment is required. There are some who believe that the introduction of an additional vapor retarder between the roofing layers can cause moisture collection and deterioration.

### FASTENER TYPE

CertainTeed recommends using nails rather than staples. Nails provide more resistance against underlayment tear out. It is very important, whether hand nailing or using a pneumatic gun, that the fasteners be driven flush.

### INSTALLATION METHOD:

When applying underlayment the key is to keep the product as wrinkle free as possible.

1. Unroll the underlayment parallel with the eaves. The eaves edge of the underlayment should go **OVER** the drip edge eaves flashing, but go **UNDER** the drip edge flashing along the rake.

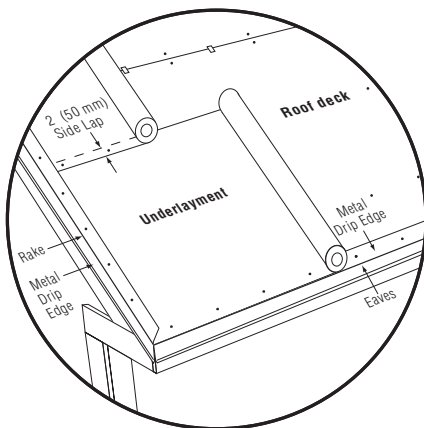


Figure 5-1: Applying Water-Resistant Underlayment Along The Eaves And Rake

2. Around the perimeter of the underlayment, place the nails approximately 6 inches apart and about 1 inch in from the edge. In the main area of the underlayment, two rows of nails are used. The first is placed 12" up from the bottom edge and the second is 24" from that same edge (or in fact 12" from the upper edge). This nicely separates the 36" wide underlayment sheet into thirds. Nail along these two rows 12-15" apart. Nail placement should be alternated so that one row places the nail opposite the open area of the first, creating a sort of zigzag pattern. This will result in a simple pattern with all nails being approximately 12-15" apart. (See tips above.)

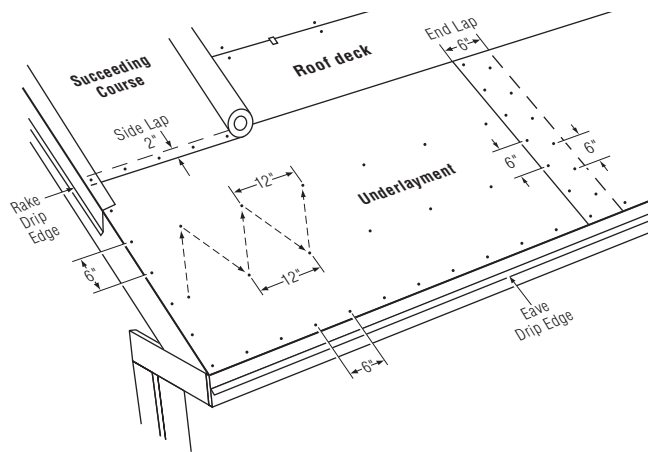


Figure 5-2: Standard Nailing Pattern For Water-Resistant Underlayment

3. Succeeding courses should be unrolled in a similar manner overlapping the previous course by 2". Be careful to roll it out straight as the underlayment will tend to slide down the pitch of the roof and end up crooked. The spacing of nails in this overlap area should be approximately 6" apart, centered in the 2" area. (See tips below.)
4. If the length of the roll is not sufficient to complete the entire run, an end lap of 6" is required. We recommend two rows of nails 6" apart to hold the lapped edges in place. End laps should be located 6-8' from any other end lap that may be in the preceding underlayment course.

**Here's a Tip...** Lay underlayment approximately 6" from both sides over hips, ridges, and valleys. Where the roof meets a vertical surface, install the underlayment about 4" or more up the surface.

---

## WARNING

When installing underlayment where hot vent stacks protrude (from wood burning stoves etc.), it is important to allow a minimum 2" clearance. Check fire codes.

### HIGH WIND / OVERNIGHT RECOMMENDATIONS:

If planning to leave water-resistant underlayment exposed overnight, or for a longer period of time, or if high winds are expected, any of the following suggestions or a combination of them can be used for additional protection:

- ◆ Use cap nails or tin caps.
- ◆ Decrease the nailing spacing recommended above, using additional fasteners.
- ◆ Nail 2x4 stringers across lap areas.

---

## DEALING WITH WRINKLES AND BUCKLES

Organic felts expand when wet. They can wrinkle after being applied to a wet deck or if moisture is absorbed from dew, rain, or snow. If shingles are applied over an uneven underlayment surface, some of the wrinkles may “telegraph” (show) through on the finished roof. Of course, wrinkles and buckles can also result from incorrect installation.

If these problems appear, several approaches are available to eliminate them. First, the underlayment can be replaced. Second, the wrinkles can be cut and repaired with patches and asphalt plastic cement. Third, wet and wrinkled underlayment can be allowed to dry out naturally from exposure to the sun. As the underlayment dries, the wrinkles often “pull down” and disappear.

The best solution for wrinkled underlayment is prevention. Applying high quality, well-saturated felt, such as Roofers’ Select™, will eliminate many wrinkling type problems. Ask your supplier for the highest quality he can obtain. Do not assume the underlayment he stocks is the best available. Be willing to pay more for a superior product. The cost of high quality underlayment adds very little to the cost of a job and can often be offset by the savings from reduced rework and repair. Installers who insist on the lowest prices for underlayment are the cause of the low quality underlayment generally found in supplier warehouses.

### DIAMOND DECK INSTALLATION METHOD:

Apply DiamondDeck only to a clean, smooth nailable deck. DiamondDeck acts like a vapor retarder; therefore, CertainTeed strongly recommends that it be installed over adequately ventilated attic spaces. Application method is dependent on roof slope, anticipated exposure time, anticipated wind speeds, and climate. If the roof is in a climate where ice damming may occur, then first apply an ASTM D1970-compliant underlayment such as CertainTeed’s WinterGuard™ Waterproofing Shingle Underlayment to all eaves. Do not install DiamondDeck as ice dam protection along eaves. Two layers of DiamondDeck cemented together is not an equivalent to WinterGuard.

- **Standard Slope Roofs (4:12 or Greater):** Starting at the lower edge of the roof, apply DiamondDeck horizontally (parallel to the eave) with printed side facing up. When necessary, overlap vertical side/end joints a minimum 6" and “weather lap” horizontal joints a minimum 3". Fasten as described below.
- **Low Slope Roofs (2:12 to <4:12):** Starting at the lower edge of the roof, apply DiamondDeck horizontally (parallel to the eave) with printed side facing up. When necessary, overlap vertical side/end joints a minimum 12" and horizontal joints a minimum 20", offsetting all vertical side/end joints from course to course a minimum of 36". Fasten as described below.

### Fastening: DO NOT USE STAPLES!

- **Short-term exposure (<2 days):** When the finished roofing will be installed within two days of underlayment application and high winds are not forecast, standard roofing nails with 3/8" diameter heads may be used. Attach the underlayment at each diamond (◇) printed on the underlayment by nailing a fastener through each diamond (◇) and tight to the surface. Proper fastener spacing is 15" On-Center (O.C.) vertically and 12" O.C. horizontally. On vertical side/end laps install 8 fasteners equally spaced (6" O.C.) centered up the lap to hold the underlayment in place. If wind or rain is expected prior to finished roofing application, it is recommended that 1" diameter plastic or steel cap nails be used in place of standard roofing nails, as described below.
- **Long-term exposure (max. six months):** When anticipated exposure time may exceed two days, CertainTeed strongly recommends using low-profile plastic or steel cap nails with 1" diameter heads to fasten DiamondDeck in place. Attach the underlayment at each diamond (◇) printed on the underlayment by nailing a fastener through each diamond (◇) and tight to the surface. Proper fastener spacing is 15" O.C. vertically and 12" O.C. horizontally. On vertical side/end laps install 8 fasteners equally spaced (6" O.C.) centered up the lap to hold the underlayment in place. All nails and plastic or steel caps must lie flat and tight with the underlayment surface. Do not expose underlayment for more than six months prior to installing finished roofing.

### Lap Sealing

Where laps or joints require sealant or adhesive, use a high quality asphalt roofing cement meeting ASTM D4586 Type II or cements/caulks based on butyl rubber or urethane. It is particularly important to seal all lap seams in areas where the underlayment will be exposed to wind-driven rain.

---

*Note: . . . The plastic release film on WinterGuard is slippery. Avoid stepping on the release film after it has been removed, or on WinterGuard itself when the release film is still attached.*

*Here's a Tip. . . On hot days put WinterGuard in your truck with the AC kicking for 20 minutes to cool it off before working with it. (Thanks to Mark Dulz, Richmond, MI.)*

---



*Here's a Tip... In addition to being used for ice-dam protection and valley liners, it is good practice to use WinterGuard to seal around pipes, skylights, chimneys, sidewalls, dormers, roof transitions and other roof areas vulnerable to leaks.*

## WATERPROOFING SHINGLE UNDERLAYMENT

CertainTeed's waterproofing shingle underlayment is called WinterGuard™. WinterGuard is a long-lasting self-sticking modified asphalt on a glass mat reinforcement. In all cases the product must be applied to a clean dry roof deck.\* The cost is much higher than standard water-resistant underlayment because of the high percentage of asphalt and polymer modifier. WinterGuard is warranted against leaks and it is not destroyed when nails are driven through it because it seals around nails as they are driven. It is designed to seal the roof and prevent water from getting inside a building due to ice dams and/or wind-driven rain.

CertainTeed's MetaLayment™ is also available for use as a waterproofing underlayment beneath metal, shingle, slate or mechanically-fastened tile roofs. MetaLayment has a slip-resistant film surface designed to improve foot traction and resist high temperatures generated by metal roofs. ASTM standard D1970 applies to WinterGuard, MetaLayment and other similar products.

### WHERE IS WINTERGUARD USED?

WinterGuard can be used on both new or existing decks. It is installed beneath shingles, slate, tile, or cedar shakes. Only WinterGuard - HT and MetaLayment can be installed beneath metal roofing. WinterGuard is easy to apply and an excellent underlayment for low-slope shingle applications. It is commonly used to protect against water backup caused by ice dams at the roof eaves. It is also used in critical areas such as valleys, and as concealed flashing around roof penetrations and up sidewalls. In addition, WinterGuard is very useful on roofs exposed to occasional high winds where wind-driven rain can penetrate beneath shingles.

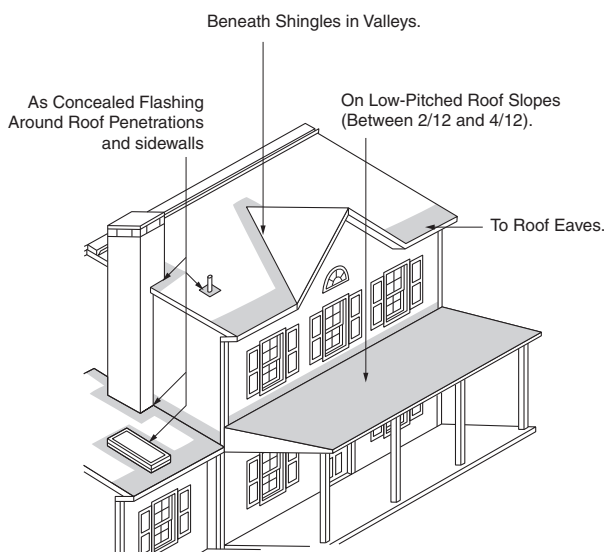


Figure 5-3: WinterGuard's many uses.

\* Miami-Dade County acceptance requires the application of WinterGuard over mechanically fastened #30 felt or #43 base sheet, and not directly to the deck. Such application is acceptable only when required by local code in areas where ice damming does not occur. Doing so will not affect the product's limited warranty.

### THE APPLICATION OF WINTERGUARD™ OVER OLD SHINGLES

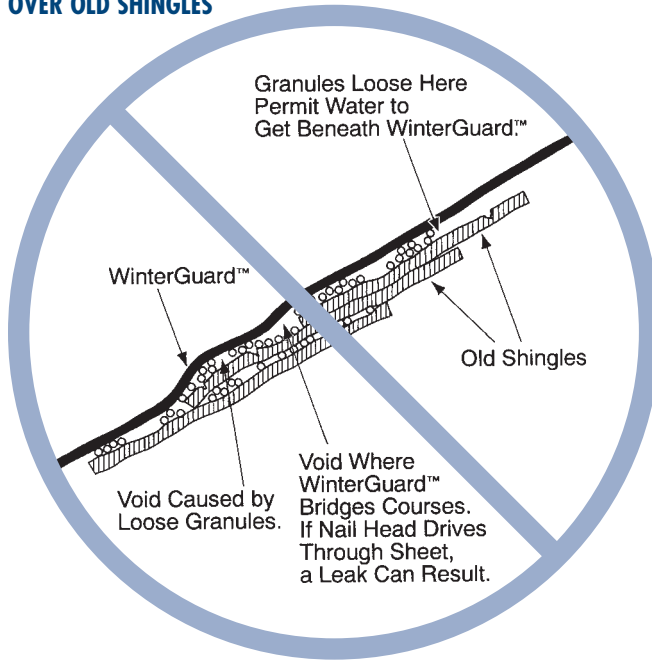


Figure 5-4: Problems with WinterGuard application over old roof.

WinterGuard™ must be applied over a clean, dry deck. Any other application, such as over old shingles, will void the WinterGuard warranty.

### WHAT IS THE DIFFERENCE BETWEEN WINTERGUARD AND STANDARD UNDERLAYMENT?

All the No. 15 and No. 30 underlayment products will wrinkle somewhat when dampened. Some will wrinkle very badly. All felt underlayments can leak, especially if they are cut to make them lie flat after they have wrinkled, and they can leak around nails driven through them.

Waterproofing shingle underlayments, such as CertainTeed's WinterGuard, do not wrinkle from moisture absorption. They do not need to be cut to flatten wrinkles, because when properly installed, there are no wrinkles. Once adhered, they will not blow off the roof. They do not leak around nails driven through them, because the thick layer of polymer-modified asphalt coating is designed to be sticky and flexible, so it seals around the nails that puncture it. Therefore, these underlayments are not just water-resistant, they are waterproof. But they must be applied fully adhered to a clean, dry wood deck, in accordance with the manufacturer's specifications, in order to get the promised performance. And nails must be properly set according to manufacturer's requirements.

### HOW IS WINTERGUARD MADE AND HOW DOES IT WORK?

WinterGuard is a composite material of asphalt and elastomeric polymers reinforced with a fiber glass membrane. It is formed into a rolled sheet. The rubberized asphalt provides the waterproofing. The polymers make the asphalt elastic and sticky all the way through the membrane. This means WinterGuard has the ability to both stretch and cling, and not rip when stressed. It seals like a gasket around nails driven through it. It sticks to a clean roof deck like glue and is warranted to remain effective for the life of the new asphalt shingle system applied over it, up to 50 years.

*Here's a Tip... Using the "Fly-In" Method, place your thumbs down. It makes the job easier in hot weather, to let go of the sticky WinterGuard. (Thanks to Mike Dempsey of Eagle River, WI.)*

## HERE ARE SOME OTHER FACTS ABOUT WINTERGUARD™

- ◆ WinterGuard is available in two different surface styles – sand and granular. WinterGuard - HT (high tack and high temperature) has a film surface. It is more flexible than sand or granular surfaced WinterGuard and can withstand high temperature roof applications, including metal or tile.
- ◆ The standard roll of WinterGuard is 65' in length and 3' wide. One standard roll contains 195 square feet of material. Sand-surfaced WinterGuard and WinterGuard HT also comes in a handy "Short Roll" that is 32 ½' long and 3' wide. It contains 97 ½ square feet of material.
- ◆ A roll of MetaLayment is 61' in length and 39 ¾" wide containing 200 square feet of material.
- ◆ During installation, an initial light "tack" (stickiness) makes WinterGuard easy to lift if you accidentally put it in the wrong place. The aggressive "tack" of WinterGuard - HT is not as forgiving.
- ◆ Once WinterGuard is installed, however, it locks tight after being warmed by the sun. If an immediate seal is desired, press overlaps firmly with a roller. A heavy-duty wallpaper seam roller or "J" roller works well.

### CAUTION:

- ◆ To help prevent shingles from fusing to the waterproofing underlayment, cover sand or granular-surfaced WinterGuard with a layer of felt-underlayment or use film-surfaced WinterGuard HT. Adopting this practice will serve the property owner and your fellow roofing contractor well when it comes time for the next re-roof.
- ◆ WinterGuard may not come in contact with excessive amounts of petroleum solvent-based cements, such as asphalt plastic cement. For use with WinterGuard, CertainTeed recommends urethanes or polymer-modified cements. Use such materials sparingly.
- ◆ Do not apply over shingles. With the exception of certain roof penetration flashing details do not apply over water-resistant underlayment.\*
- ◆ If necessary, you may apply new WinterGuard over an older existing piece of WSU; however, be sure the following conditions are met in order for the WinterGuard warranty to remain in force:
  - The underlying roof deck must be acceptable and in good condition.
  - The existing WSU must have a smooth, clean surface. Nail holes can be present, but all shingles, nails, etc. must be removed and the existing WSU surface swept clean.
  - The surface of the existing WSU must be primed with an ASTM D41 asphalt primer in order to achieve proper adhesion when applying WinterGuard sand or granular. The use of asphalt primer prior to applying WinterGuard HT over an existing WSU surface is strongly recommended.
  - All laps must be offset between the existing WSU and new WinterGuard by at least 8".
  - "Feather" the high edge of the WinterGuard over the existing WSU to avoid telegraphing its double thickness.

\* Miami-Dade County acceptance requires the application of WinterGuard over mechanically fastened #30 felt or #43 base sheet, and not directly to the deck. Such application is acceptable only when required by local code in areas where ice damming does not occur. Doing so will not affect the product's limited warranty.

Note: CertainTeed is not responsible for and disclaims any and all liability for any damage caused by incompatibility of its WinterGuard products when applied over WSU from other manufacturers.

- ◆ Do not use WinterGuard as a permanently exposed roofing surface because it will begin to degrade after too much exposure to ultraviolet light. However, after being properly applied to an acceptable deck, WinterGuard can be left exposed for three to six months (depending on the weather) prior to the installation of the roofing shingles – without significantly damaging WinterGuard's performance in the finished system. When exposing WinterGuard for more than one day, we strongly recommended that you:
  - ◆ Press down all laps with a wallpaper seam roller to assure immediate adhesion. End laps should be 6". Side laps for film and granular surfaced should be 4"; sand surfaced requires a 6" side lap.
  - ◆ Use additional fasteners to hold the sheet in place (especially if cool, windy weather is anticipated).
  - ◆ Close-off holes and joints in the roofs, since the finished roofing system and its flashing components will not be in place to prevent leakage.
  - ◆ Prior to roofing over the exposed WinterGuard, inspect it for damage and replace or recover any worn areas. If any fasteners are removed, the WinterGuard must be replaced or the holes must be filled with one of the adhesives mentioned above so that it remains watertight.

### WARNINGS

- ◆ Always remember that roofing activity can be dangerous. All necessary precautions and safety guidelines should be observed in accordance with proper roofing trade practices.
- ◆ Film-surfaced WinterGuard HT can be slippery when walked on.
- ◆ When sand-surfaced WinterGuard is left exposed for long periods of time, the sand embedded in its top surface will gradually come loose, possibly creating a slippery condition. Be sure to sweep the loose sand off "long-exposed" WinterGuard before walking on it. If, for any reason, you must leave WinterGuard exposed for a long period of time, you can possibly avoid the "loose-sand" situation by completely covering the WinterGuard with a standard water-resistant underlayment such as #15.
- ◆ WinterGuard's release film can be slippery. We suggest that you get the release film off the roof immediately after pulling it off each section of WinterGuard.
- ◆ WinterGuard is applied along the eaves and up the roof no less than 24" beyond the interior wall line to protect against leaks caused by ice dams. In areas of severe icing, it must be applied at least up to the highest water level that might conservatively be expected to occur from ice dams. This will vary by climate, amount of ventilation and insulation, and roof slope. For additional information on ice dams, visit [www.certainteed.com](http://www.certainteed.com).
- ◆ WinterGuard is a vapor retarder. If you apply it over the entire roof, special care must be taken to ensure there is sufficient ventilation beneath the roof deck to prevent condensation. Refer to Chapter 7 for more information on ventilation.

- ◆ WinterGuard will temporarily lose most of its sticky nature at temperatures under 40°F or even at higher temperatures, depending on its age. We recommend that it be applied in fair weather, at temperatures above 40°. If you need to apply it at colder temperatures, we suggest that you:
  - ◆ Nail it in place with fasteners. Nailing, however, cannot provide protection from ice dams.
  - ◆ Seal the laps with a heat gun or use one of the caulks/adhesives mentioned above.

Installed according to instructions, WinterGuard will become sticky again and adhere when temperatures rise.

## DECK PREPARATION

- ◆ Remove all roofing material down to a clean, dry, and smooth deck.
- ◆ Get rid of anything that is sticking up, such as nails or wood splinters. Also eliminate dust, dirt, loose objects, and moisture.
- ◆ If you are covering a concrete or masonry roof surface, prime the surface first with an asphalt primer meeting ASTM D41 requirements. Follow the manufacturer's instructions for applying the primer. The primer must be dry before installing WinterGuard.

## THREE INSTALLATION METHODS

### (1) THE "ROLL-OUT" APPLICATION METHOD

**NOTE:** This method requires two workers.

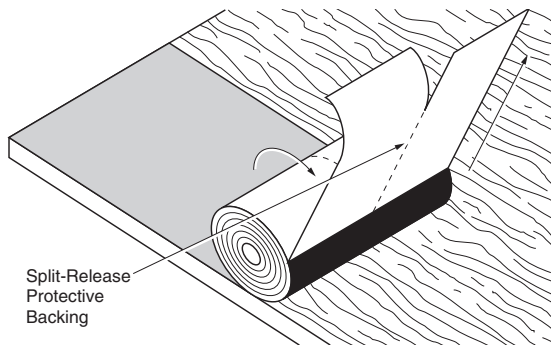


Figure 5-5: Application using the "Roll-Out" Method.

1. WinterGuard can be applied in any length convenient to the applicator.
2. First, unroll the material (keeping protective release film in place), line up with the lower edge of the roof, and hold it in place.
3. Lift the starting-end of the material (approximately 1'), peel back, and fold under at least 6" of both protective release film sections.
4. Carefully return the exposed adhesive surface to the deck and press it firmly in place. It is recommended that you walk over WinterGuard to set it firmly to the deck.
5. If it's cold and the material does not stick immediately, tack in place with a few fasteners.
6. Reroll the material from the other end until the peeled and folded-back film is exposed.
7. Beginning with the already peeled release film, continue to peel both sections of film from the roll, pulling the roll parallel to the eaves (Figure 5-5). Be sure the WinterGuard lays flat and is sticking well.
8. Press overlaps firmly into place with a hard roller.

### (2) THE "PEEL AND FLOP" APPLICATION METHOD

**NOTE:** This method is recommended for one-worker applications.

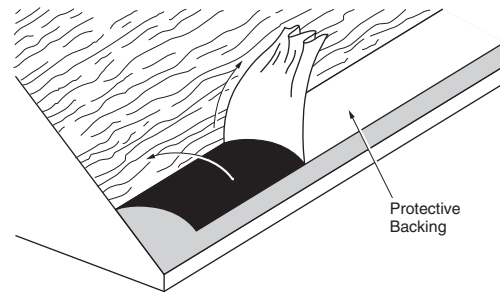


Figure 5-6: Application using the "Peel and Flop" Method.

You can apply WinterGuard with the "Peel and Flop" method, using the "two-piece, split-sheet, release-film" feature to adhere the longitudinal halves, one at a time. This feature allows one person to position the sheet before removing the protective plastic sheeting on the underside, then flop it back, peel off the release film, and set it, all without help. Press overlaps firmly into place with a hard roller. It is best to cut the product into manageable lengths of about 12' when applying WinterGuard by this method.

### (3) THE "FLY-IN" APPLICATION METHOD

**NOTE:** This method requires two workers.

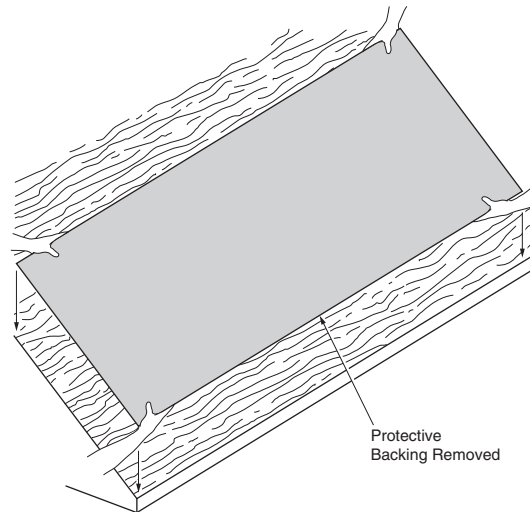


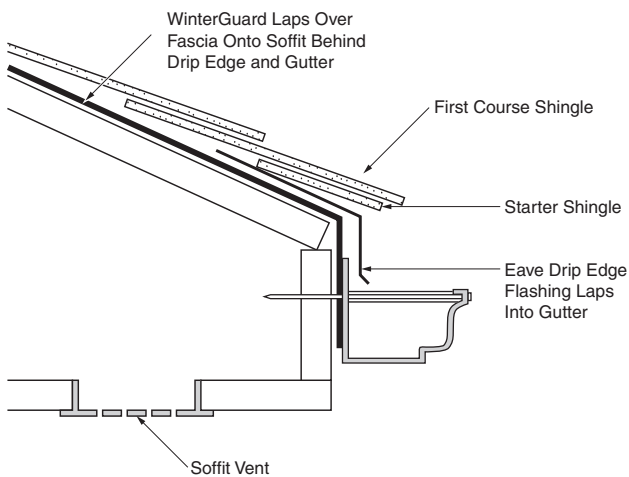
Figure 5-7: Application using the "Fly-In" Method.

1. Cut WinterGuard to a convenient length and dry-fit the sheet to its proper location before removing the plastic release film.
2. Turn the entire sheet over and remove all the protective release film.
3. Pick up the sheet of WinterGuard from both ends and turn it over. Be careful that the wind doesn't catch the sheet when it's raised off the roof. In fact, don't even try this method on a windy day.
4. Drop or "fly" the sheet into place, using great care to assure correct placement (Figure 5-7).
5. Press the sheet firmly against the deck to be sure of complete adhesion. It is recommended that you walk over WinterGuard to set it firmly to the deck.

## APPLYING DRIP EDGE

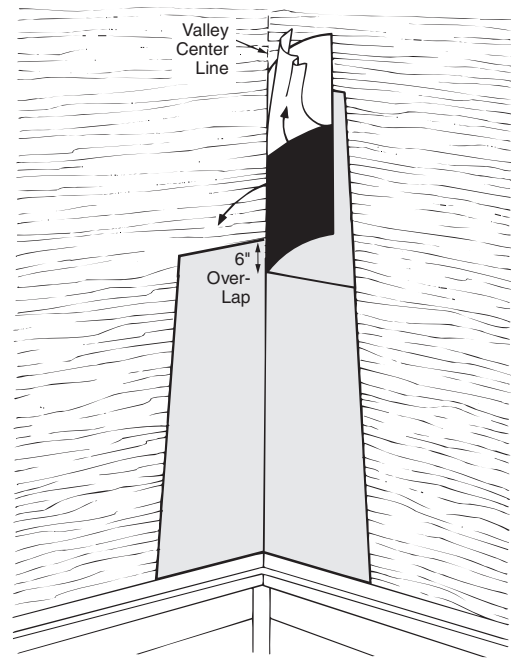
1. Drip edge must be applied so that the higher pieces will overlap the lower pieces.
2. At the rake, drip edge may be installed under or over WinterGuard. When drip edge is installed over WinterGuard, the WinterGuard must cover the top of rake board.
3. At the eaves, if there is a chance of snow or ice build-up in the gutters, install drip edge over WinterGuard. WinterGuard must cover top of fascia board. In severe ice dam regions, WinterGuard can be wrapped over the fascia board and, if desired, onto the soffit. Cover all exposed WinterGuard with drip edge, gutter, wood or other weather-resistant material to protect it from damage. If there is no chance of snow or ice build-up in the gutters, install drip edge under the WinterGuard.

**DEFEATING ICE BUILD-UP IN GUTTERS:** Ice build-up in gutters will often allow meltwater to intrude behind fascia boards. Depending on construction of the eaves, deterioration of soffits or even interior damage can occur that looks like a roof leak. One method to solve this problem is shown in *Figure 5-8*. Another method is to wrap WinterGuard™ down the fascia onto the soffit, and nail a furring strip to hold WinterGuard tightly in place. This strip also serves as a UV block. Install the gutter in front of the WinterGuard-covered fascia. Then install the drip edge on the eaves over WinterGuard. Make sure the drip edge extends well into the rain gutter as shown in *Figure 5-8*, so UV rays are prevented from reaching WinterGuard. If the fascia is wider than about 6" WinterGuard must be stopped behind the gutter to prevent exposure to UV. This approach may not be compatible with vinyl fascia systems due to the chemical reaction which may cause the asphalt to bleed onto the vinyl.



*Figure 5-8: Application down the fascia to protect against ice build-up in gutters.*

## APPLYING WINTERGUARD ON VALLEYS



*Figure 5-9: Valley application using the two-man "Peel and Flop" Method.*

1. In valleys, the width of the material must be 36" minimum.
2. Apply WinterGuard using the "Peel and Flop" method described earlier. This time, however, be sure to use two workers to handle the sheet.
3. Be sure you're getting good adhesion down the valley centerline. WinterGuard must conform smoothly to the valley. If fasteners are required (because of cold weather or a steep slope), they must be no closer than 6" to the valley centerline.
4. In valleys, start the application at the low point and work upward.
5. To assure waterproofing, overlap all WinterGuard sheets 6" at lap joints. The uppermost portion must overlap the lower portion. A hard roller is recommended to roll and press WinterGuard in place at the laps.
6. Do not use WinterGuard as a permanent weathering surface in open valleys (or elsewhere).



## APPLYING WINTERGUARD ON LOW SLOPES

1. WinterGuard can be applied under shingles to provide protection against wind-driven rain water on low-slope applications.
2. The minimum approved slope for WinterGuard application is 2/12. If applied to cover the entire roof, ensure sufficient ventilation to avoid condensation.
3. It is especially important to assure adhesion at the laps by pressing all overlaps into place with a hard roller.

Note: WinterGuard HT can be applied under metal roofing on slopes of 0.5/12 (for all other types the minimum approved slope is 2/12).



Figure 5-12: SA Cap.

## IMPORTANT APPLICATION CONSIDERATIONS

- ◆ Do not attempt application if ice, snow, moisture or dew are present. Bonding substrates must be clean, dry and free of dust or other inhibitors of proper adhesion. Ambient temperature must be 50°F or above.
- ◆ Store Flintlastic SA rolls indoors on pallets, protected from the elements. Rolls that are improperly stored or have been warehoused for prolonged periods of time may lose their tack.
- ◆ Do not apply membrane that has been improperly stored, exposed to moisture, or has lost its tack. If the material isn't bonding, STOP the application!
- ◆ Always remember to put safety first and follow all OSHA safety guidelines with any roofing installation.
- ◆ Substrates must be free of dust, dirt, oil, debris and moisture.
- ◆ Primer, if used, must be applied at the specified rate and must be allowed to thoroughly dry.
- ◆ Work with manageable lengths of Mid Ply and Cap for the particular job. Where appropriate, cut rolls into 1/3- or 1/2-roll lengths and allow material to relax prior to installation.
- ◆ In cooler weather, a hand-held hot air welding gun can be used to warm the sidelap areas and improve adhesion (prior to application of the FlintBond SBS Modified Bitumen Adhesive).
- ◆ Use caution with the weighted roller at endlap areas. Don't squeeze out too much adhesive.
- ◆ When applying Mid Ply (or PlyBase) directly to substrate, design adequate roof ventilation into the system through the use of roof relief vents.
- ◆ Do not mix Flintlastic SA membranes with other types of roof membranes. Flintlastic SA membranes are specifically designed to be applied together. The permanent top film of the Mid Ply, PlyBase and NailBase cannot receive torching, hot asphalt or other non self-adhering application methods. The Flintlastic SA Cap (or SA Cap FR), PlyBase and Mid Ply cannot be applied to any surfaces other than as described herein.
- ◆ Do not use cold adhesives with Flintlastic SA membranes other than for flashing details and cap sheet overlaps as described herein.

## ★ FLINTLASTIC® SA ROOF SYSTEMS

### SELF-ADHERING SBS MODIFIED BITUMEN ROOFING SYSTEM FOR LOW SLOPE ROOFS

CertainTeed Flintlastic SA is a premium, self-adhering SBS modified bitumen roofing system. Components of the Flintlastic SA system include:

- Flintlastic® SA NailBase (mechanically attached)
- Flintlastic® SA PlyBase (self-adhering)
- Flintlastic® SA Mid Ply (self-adhering)
- Flintlastic® SA Cap (self-adhering)
- Flintlastic® SA Cap FR (fire-rated, self-adhering)

The Flintlastic SA products can be used in various 2-ply or 3-ply system configurations, depending upon the roof requirements.

The advantages of self-adhering membrane are ease of application, minimum of installation tools or equipment needed, cleanliness, and the fact that no hot asphalt or torches are required for installation.

Refer to the CertainTeed Commercial Roof Systems Specification Manual or Flintlastic SA Installation Guide for product data sheets, complete specification details, and warranty information. Product application must comply with CertainTeed installation instructions. Roofs and decks must have proper drainage.



Figure 5-10: SA Base.



Figure 5-11: SA Mid Ply.

## DECK PREPARATION

CertainTeed recommends the use of Flintlastic SA NailBase base sheet in conjunction with all self-adhering membrane roof installations. Flintlastic SA NailBase can be mechanically attached to nailable substrates or applied using hot asphalt (non-nailable substrates). For non-nailable substrates where use of hot asphalt to adhere the base sheet may not be appropriate, Flintlastic SA Mid Ply or Flintlastic SA PlyBase may be used in lieu of Flintlastic SA NailBase on surfaces properly primed with FlintPrime™ SA. However, note that without the use of a base sheet, the membrane may be difficult to later remove (if necessary) and certain UL and FM listings for the products may not apply. Prior to application of Flintlastic SA products, ensure roofs have positive drainage. Consult the local building official for minimum slope and drainage requirements.

## APPLICATION OF FLINTLASTIC SA NAILBASE

Beginning at the low point of the roof, mechanically fasten Flintlastic SA NailBase to nailable deck using appropriate fasteners (see fasteners chart below). Start with an appropriate roll width (1/3 or 1/2 roll) to accommodate offsetting of sidelaps of subsequent layers of Mid Ply and/or Cap sheet. Install so that no sidelaps are against the flow of water. A minimum fastening pattern is every 9" on center on sidelaps and every 18" on center in two staggered rows in the field of the sheet.

\* (Use Type III asphalt for slopes under 3" per foot; Type IV asphalt for slopes over 3" per foot. Spot mopping may be appropriate. Consult CertainTeed.)

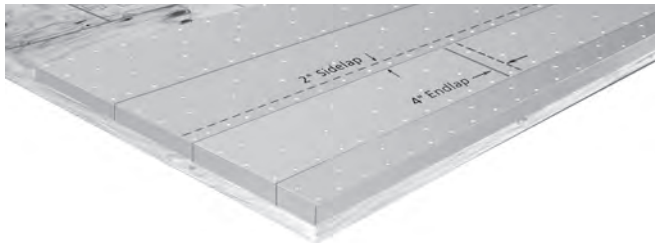


Figure 5-13: Fastening SA Base on a nailable deck.

<p><b>Standard (Round Head) Roofing Nails and Cap</b> (Note: CertainTeed does not permit the use of plastic caps) For use with Base Sheet, Flash/Termination Bar on Plywood Decks, Non Veneer Decks, Wood Plank Decks</p>
<p><b>Large Head Roofing Nails</b> For use with Base Sheet, Flash/Termination Bar on Plywood Decks, Non Veneer Decks, Wood Plank Decks</p>
<p><b>Base Sheet Fasteners for some Cementitious Roof Decks</b> For use with Base Sheet on Light Weight Insulation Concrete, Poured Gypsum</p>
<p><b>Self-Locking Fasteners</b> For use with Base Sheet on Cement/Wood Fiber</p>

Prime non-nailable substrates such as concrete using FlintPrime SA water-based primer. Allow to dry thoroughly, but not more than 4 hours to retain tack-enhancing properties. Apply SA NailBase using ASTM Type III or IV hot asphalt\* at the rate of 25 lbs. per 100ft<sup>2</sup>, or self-adhere SA PlyBase (or Mid Ply).



Overlap base sheet sidelaps 2" and endlaps 4". Offset endlaps a minimum of 3'. Turn base sheet over fascia and fasten. Do not leave installed base exposed. Cover in the same day with Flintlastic SA Mid Ply and/or Flintlastic SA Cap (or SA Cap FR).

Don't leave the installed Flintlastic SA NailBase exposed to the weather; cover with Flintlastic SA Cap the same day.

## APPLICATION OF FLINTLASTIC SA MID PLY OR PLYBASE

Note: Proceed to "Before Installing Flintlastic SA Cap (or SA Cap FR)" if installing a 2-ply system.

Before installing Flintlastic SA Mid Ply (or PlyBase), sweep the underlying base sheet or primed surface to remove any dust, dirt or sand particles that could interfere with adhesion.

Apply Mid Ply (or PlyBase) over installed Flintlastic SA NailBase or, for non-nailable decks such as concrete, properly primed substrates (see above). Surface must be dry and free from dust or dirt. Start Mid Ply (or PlyBase) application at the low point of the roof with appropriate roll width to offset sidelaps 18" from sidelaps of base sheet. Install flush to roof edge if over base sheet, otherwise turn the Mid Ply (or PlyBase) over the fascia minimum 2" and secure. Design layout so that no sidelaps are against the flow of water.

Cut rolls into manageable lengths. Fold the membrane back halfway lengthwise to remove the split release film. Press membrane securely into place, and repeat with the opposite half of the membrane. Use a heavy, weighted roller over the entire surface of the Flintlastic SA Mid Ply (or PlyBase) membrane to secure the membrane. Work outwards to eliminate voids.



Figure 5-14: Fold membrane back halfway and remove release film.

**NOTE:** CertainTeed offers a variety of commercial roofing products (MOD-BIT, BUR and self-adhered membrane) that can be used on residential flat roofs such as carports, porches, Florida rooms, etc. Visit us @ [www.certainteed.com](http://www.certainteed.com) or request a CertainTeed Commercial Systems Specifications Manual to learn more.



Figure 5-15: Roll seams with a heavy weighted roller.

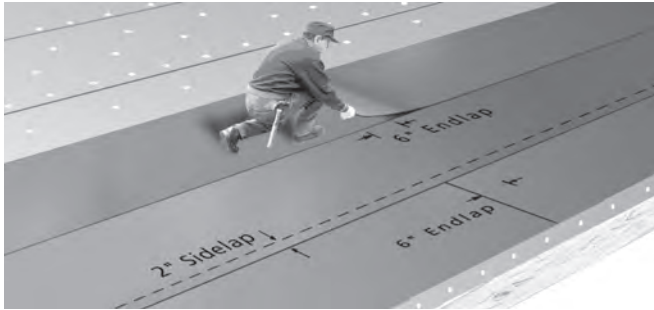


Figure 5-16: Overlap sidelaps of Mid Ply or PlyBase.

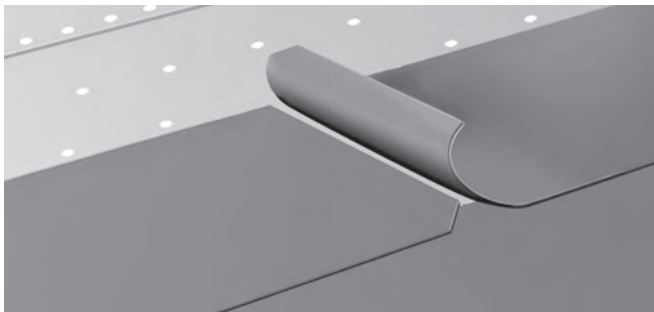


Figure 5-17: Cut endlaps at a 45° angle at opposing diagonal corners.

Overlap sidelaps of subsequent Mid Ply (or PlyBase) membrane lengths 2" and endlaps 6".

Offset (stagger) endlaps minimum 3'. Cut endlaps at opposing diagonal corners at an angle approx. 2" from the corners to minimize "T"-seams. Apply a bead or small trowel dab (quarter size) of FlintBond™ SBS Modified Bitumen Adhesive, trowel or caulk grade, at the edge of the angled cut to avoid a capillary. Use of a hand-held hot air gun at the joint area prior to rolling the membrane will maximize adhesion. In areas prone to cold temperatures, snow and freeze-thaw cycles, it may be more effective to use the hot air gun to form joints, and to completely fill all mole holes with asphalt that has been slightly melted using the gun. It is recommended to apply a bead of FlintBond SBS Modified Bitumen Adhesive, caulk grade, at all Mid Ply (or PlyBase) side and endlaps to eliminate a capillary.

Don't leave the installed Flintlastic SA Mid Ply (or PlyBase) exposed to the weather; cover with Flintlastic SA Cap the same day.

## BEFORE INSTALLING FLINTLASTIC SA CAP (OR SA CAP FR)

If roof edge detail utilizes edge metal, proceed as follows. If Mid Ply or (PlyBase) has been applied, install minimum 26 gauge edge metal using appropriate fasteners, and set entirely in a uniform 1/8"-1/4" thick troweling of FlintBond SBS Modified Bitumen Adhesive, trowel grade. Remove any oil from the metal surface using a vinegar and water solution.

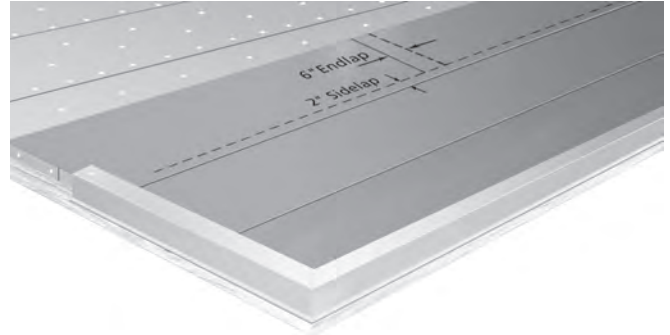


Figure 5-18: Install minimum 26" gauge edge metal

Prime the horizontal surface of the metal with FlintPrime SA and allow primer to dry. Apply a bead of caulk grade FlintBond adhesive to the edge of the metal where it meets the Mid Ply (or PlyBase). Proceed with Flintlastic SA Cap (or SA Cap FR) installation.

If Mid Ply is not specified: Over the Flintlastic SA NailBase, install a wide strip of Mid Ply to that dimension extending 6" onto the field of the roof and flush to the roof edge, self-adhered. Install minimum 26 gauge edge metal using appropriate fasteners, set entirely in a uniform 1/8"-1/4" thick troweling of FlintBond SBS Modified Bitumen Adhesive, trowel grade. Prime the horizontal surface of the metal with FlintPrime SA and allow primer to dry. Apply a bead of caulk grade FlintBond SBS Modified Bitumen Adhesive at the roof side edge of the metal where it meets the Mid Ply strip. Proceed with cap sheet installation.

Similarly, complete your sheet metal flashing installation using cut Mid Ply strips at all flashing details prior to flashing application. Seal edges of Mid Ply flashing strips with a bead of FlintBond. If Mid Ply has been installed as part of the system, set flanges in trowel grade FlintBond and properly fasten. All cap sheet flashings installed to transitions that overlap onto mineral surface must be set in a uniform troweling of FlintBond trowel grade adhesive.



## APPLICATION OF FLINTLASTIC SA CAP (OR SA CAP FR)

Before installing Flintlastic SA Cap (or SA Cap FR), sweep the surface of the installed SA NailBase (or PlyBase) or Mid Ply clean. To install Flintlastic SA Cap (or SA Cap FR), start at the low point of the roof with an appropriate roll width to offset sidelaps from the underlying membrane a minimum of 18". Work with manageable lengths for proper handling.



Figure 5-19: Install SA Cap or SA Cap FR at the low point of the roof.

Position SA Cap (or SA Cap FR) with selvage edge release strip at high side of roof. Install in weather-lapped fashion, with no laps against the flow of water.



Figure 5-20: Position with selvage edge release strip at high side of roof.

Once positioned, lift and fold back (lengthwise) the lower half of the membrane. Remove the split release film and press firmly into place. Then repeat with the other (high side of the roof) half of the membrane.



Figure 5-21: Once positioned, lift and fold back the lower half of membrane.

Follow the same layout and split release film procedures as for Mid Ply (or PlyBase), but overlap sidelaps 3" and endlaps 6". Use a heavy, weighted roller over the entire surface of Flintlastic SA Cap (or SA Cap FR) to secure it in place and prevent voids, working outward from the center of the sheet.

As subsequent membrane lengths are installed, remove the selvage edge release strip just prior to overlapping to keep the adhesive area protected and clean. Cut endlaps at opposing diagonal corners at a 45° angle approx. 3" from the corners to minimize T-seams.



Figure 5-22: Remove the selvage edge release strip.

Use FlintBond SBS Modified Bitumen Adhesive, trowel grade, on the entire 6" width of each endlap prior to overlapping. Apply a uniform 1/8" - 1/4" troweling of the FlintBond on the entire width of the endlaps to the underlying membrane. Install the overlapping sheet. Always apply FlintBond (extend beyond underlying lap minimum 1/4") on the entire width of any overlap when applying SA Cap (or SA Cap FR) over another mineral surface such as the SA Cap (or SA Cap FR) endlap.

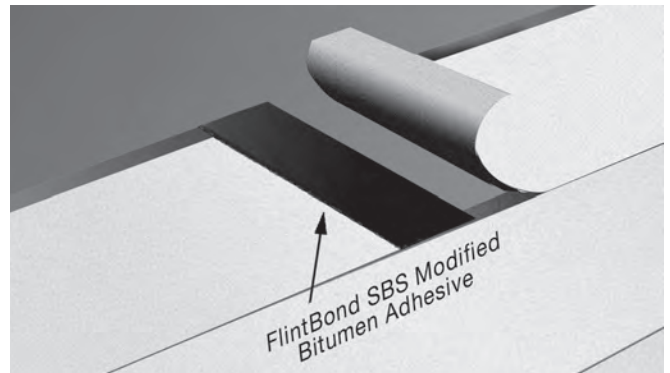


Figure 5-23: Apply FlintBond where overlaps onto mineral surface occur.

At all vertical and other flashing points, apply FlintBond SBS Modified Bitumen Adhesive, trowel grade, wherever there is an overlap onto mineral surfacing.

Once the membrane has had a chance to bond, check all laps and joints for full adhesion. If the membrane can be lifted at any area it is not properly adhered. A seam probing tool can be helpful to check for small voids at laps. If necessary, use appropriate hand-held hot air welding tool and seam roller or an application of FlintBond to seal small unbonded areas if they exist.



## THE PROPER T-SEAM DETAIL

- Before adhering Flintlastic SA Mid Ply or Cap (or SA Cap FR) endlaps, trim the underlying sheet's lower outside corner at the end of the roll.
- Follow with the overlapping sheet, trimming the upper outside corner.
- Corners shall be trimmed on a diagonal angle  $5\frac{1}{2}$ " long from end of roll to outside edge.
- Width of trim shall be equal in width to the sidelap specified (3" for Flintlastic SA Cap [or SA Cap FR] and 2" for Flintlastic SA Mid Ply [or PlyBase]).
- Trimmed corners shall be completely covered by application of succeeding courses.
- Note: If using Flintlastic SA Mid Ply (or PlyBase), apply quarter-size dab of FlintBond at T-seam area. If using Flintlastic SA Cap (or SA Cap FR), the endlap is completely set in trowel grade FlintBond along the entire 6" lap width.

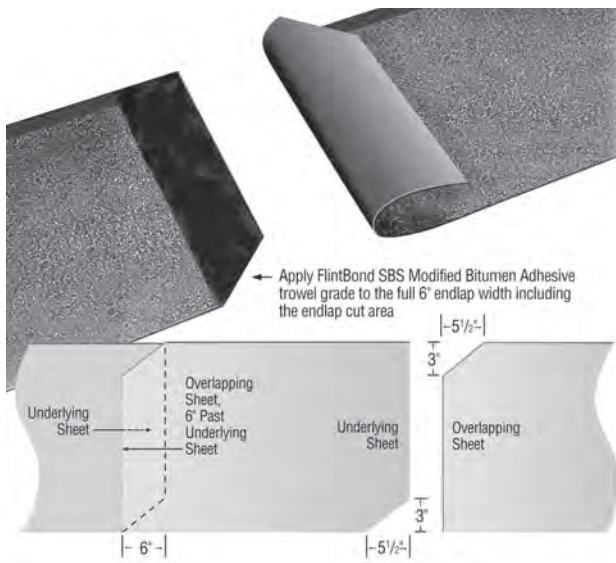
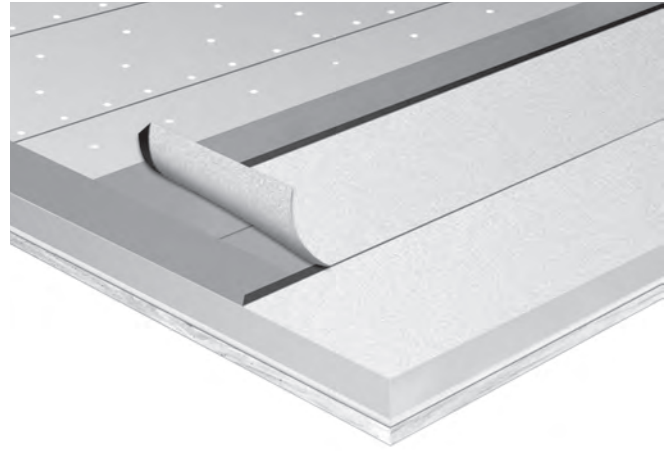


Figure 5-24: Trim the corners of the underlying and overlapping sheets as shown.

## RAKE EDGE DETAIL

- Cut selvage area at an angle at all rake edges.
- Apply a bead of FlintBond caulk along cut edge to eliminate mole holes.



**TYPICAL CONSTRUCTION DETAILS –  
FLINTLASTIC SA 2 PLY SYSTEM**

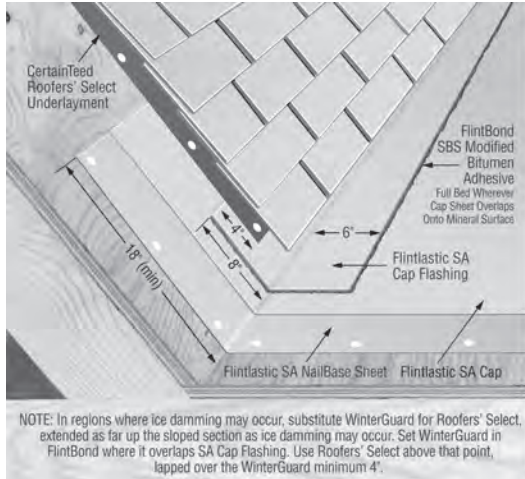


Figure 5-25: Shingle Transition 2 Ply

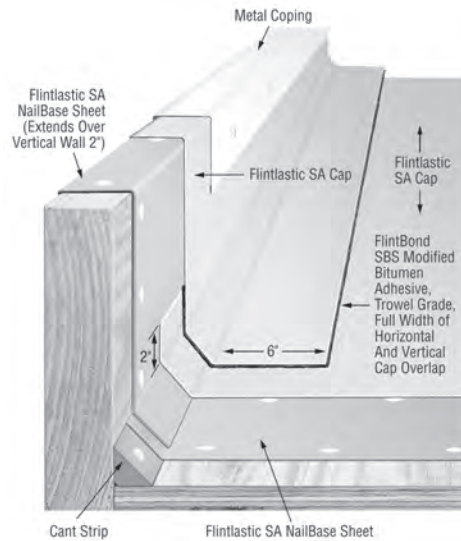


Figure 5-28: Parapet Wall 2 Ply

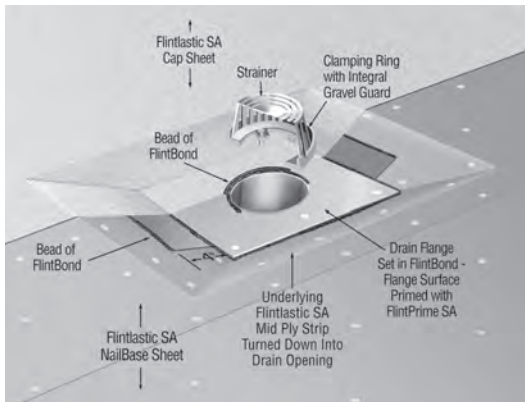


Figure 5-26: Drain 2 Ply

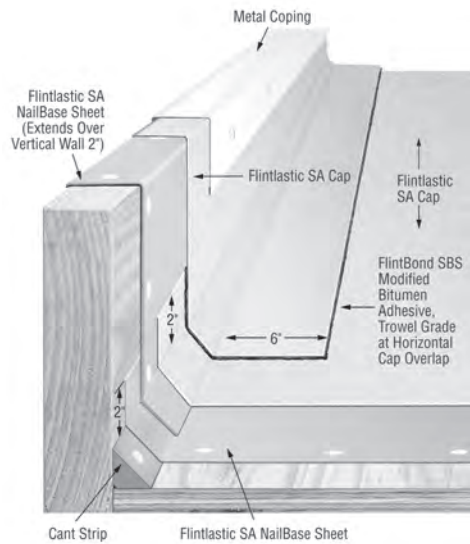


Figure 5-29: Alternate Parapet Wall 2 Ply

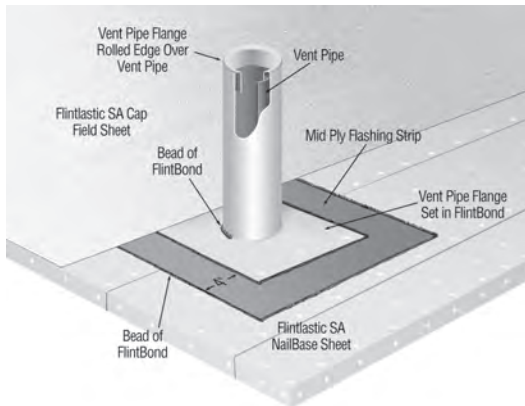


Figure 5-27: Vent 2 Ply

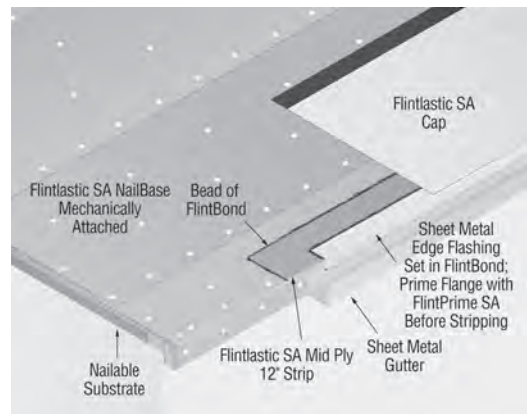


Figure 5-30: Rain Gutter Edge Detail 2 Ply

**TYPICAL CONSTRUCTION DETAILS –  
FLINTLASTIC SA 2 PLY SYSTEM (CONTINUED)**

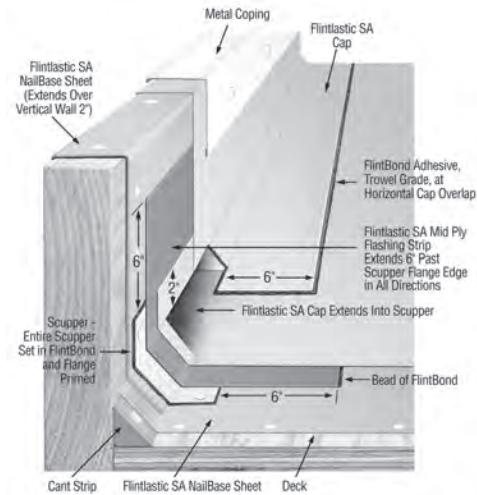
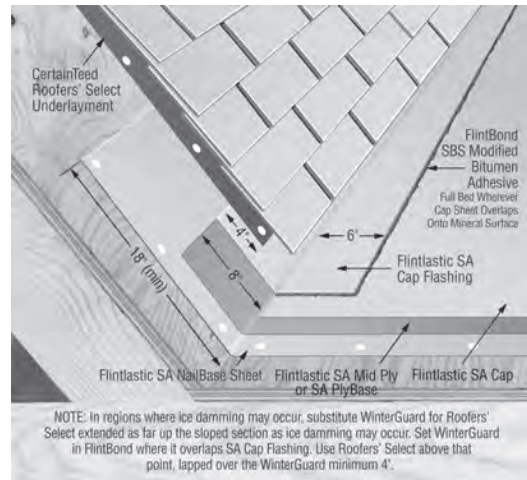


Figure 5-31: Scupper 2 Ply

**TYPICAL CONSTRUCTION DETAILS –  
FLINTLASTIC SA 3 PLY SYSTEM**



NOTE: In regions where ice damming may occur, substitute WinterGuard for Roofers' Select extended as far up the sloped section as ice damming may occur. Set WinterGuard in FlintBond where it overlaps SA Cap Flashing. Use Roofers' Select above that point, lapped over the WinterGuard minimum 4".

Figure 5-34 Shingle Transition 3 Ply

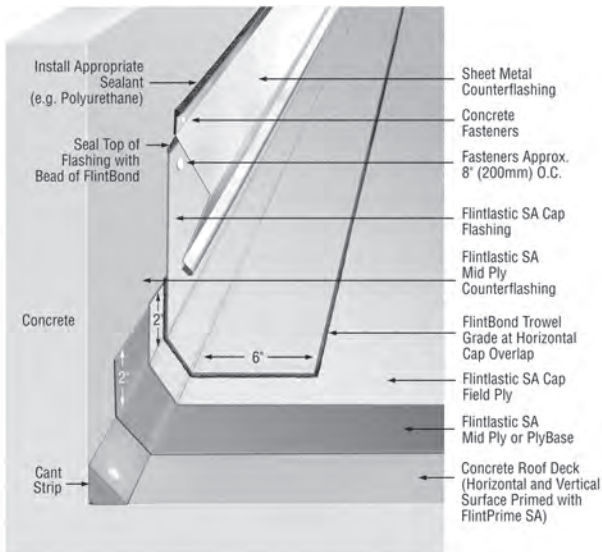


Figure 5-32: Concrete Term 2 Ply

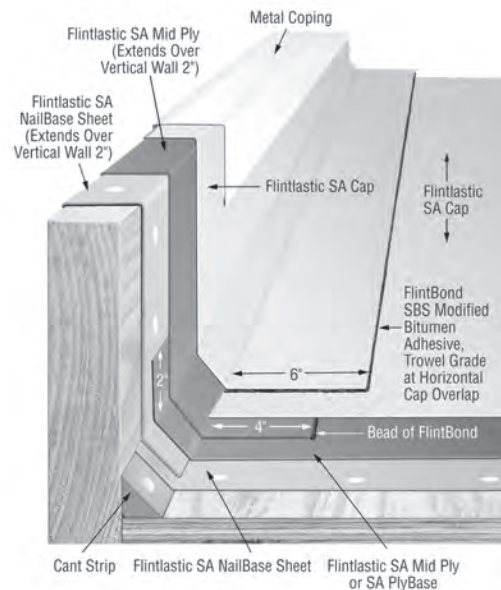


Figure 5-35: Parapet Wall 3 Ply

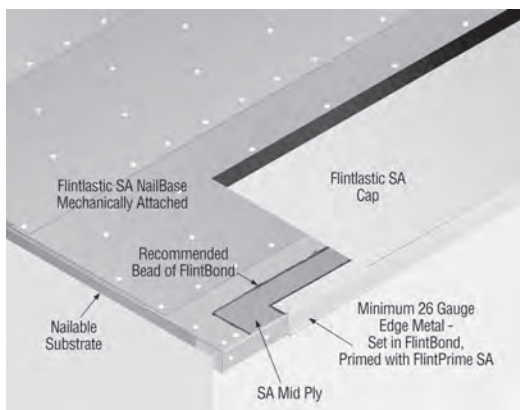


Figure 5-33: Edge Detail 2 Ply

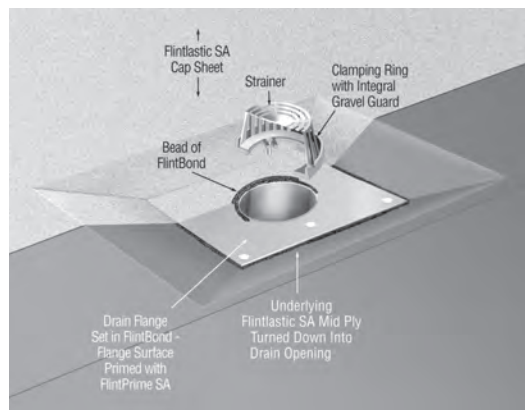
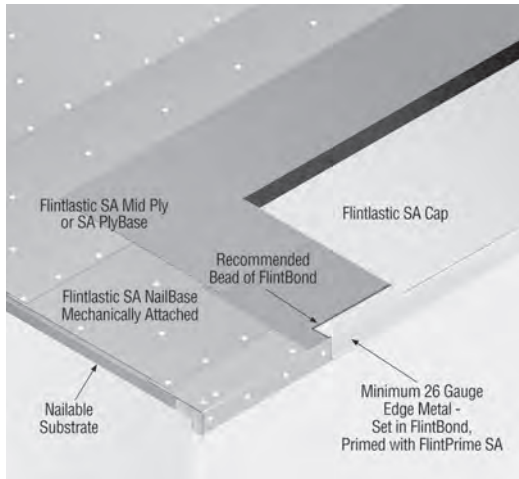


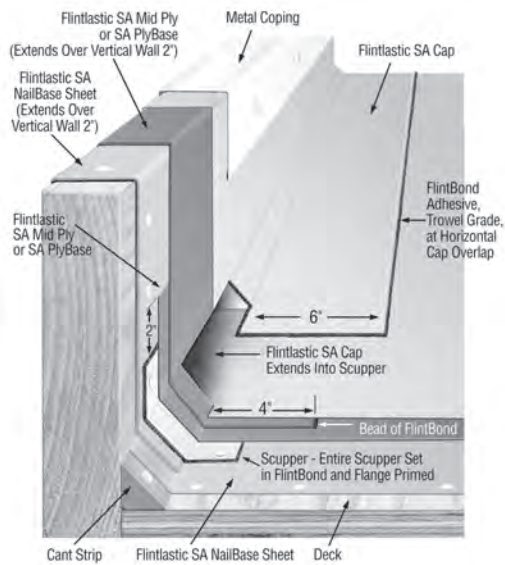
Figure 5-36: Drain 3 Ply



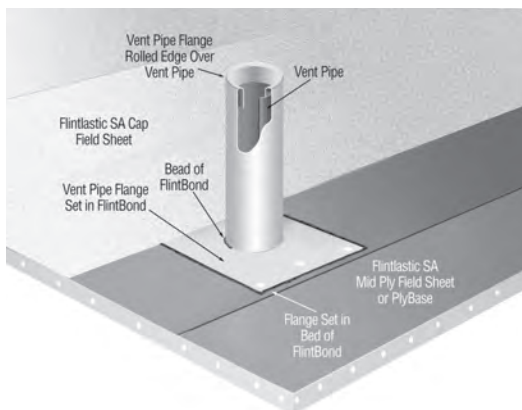
**TYPICAL CONSTRUCTION DETAILS –  
FLINTLASTIC SA 3 PLY SYSTEM (CONTINUED)**



*Figure 5-37: Edge Detail 3 Ply*

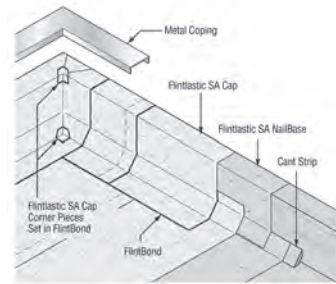


*Figure 5-38: Scupper 3 Ply*

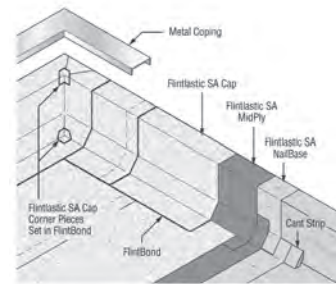


*Figure 5-39: Vent 3 Ply*

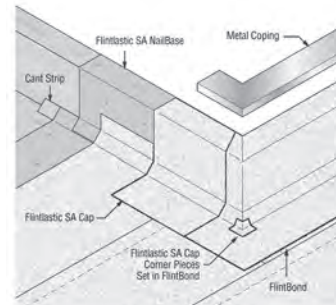
**TYPICAL CONSTRUCTION DETAILS – INSIDE & OUTSIDE CORNER  
FLINTLASTIC SA 2 PLY AND 3 PLY SYSTEMS**



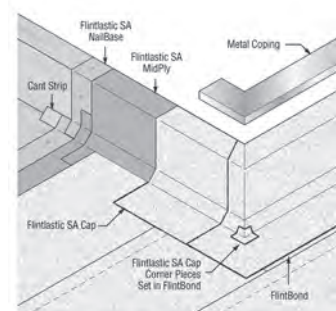
*Figure 5-40: Inside Corner 2 Ply System*



*Figure 5-41: Inside Corner 3 Ply System*




*Figure 5-42: Outside Corner 2 Ply System*



*Figure 5-43: Outside Corner 3 Ply System*



## SECTION 5 SELF-TEST

- 5-1. Roofers' Select™ shingle underlayment meets the ASTM D6757 standard and has more resistance to tearing and wrinkling than #15 type underlayment.
- A. True.  
B. False.
- 5-2. Typically, when installing water-resistant underlayment, side laps should be at least two inches and end laps at least six inches.
- A. True.  
B. False.
- 5-3. One reason to use water resistant underlayment is that it is part of Class A fire-rated shingle systems.
- A. True.  
B. False.
- 5-4. Joint overlaps for DiamondDeck are different than felt and vary by roof slope.
- A. True.  
B. False.
- 5-5. WinterGuard HT has more aggressive "tack" than granular or sand-surfaced WinterGuard and can be installed under asphalt shingles, tile or metal roofs.
- A. True.  
B. False.
- 5-6. Metalayment is a film-surfaced product that meets ASTM D1970 and can only be applied under metal roofs.
- A. True.  
B. False.
- 5-7. All shingles applied to a low slope deck require the use of WinterGuard or its equivalent applied over the entire deck.
- A. True.  
B. False.
- 5-8. WinterGuard can be installed over the fascia board to protect against ice build-up in gutters.
- A. True.  
B. False.
- 5-9. Drip edge may be applied either over or under WinterGuard along the rake.
- A. True.  
B. False.
- 5-10. At the eaves, if there is a chance of snow or ice build-up in the gutters, install drip edge under the WinterGuard.
- A. True.  
B. False.
- 5-11. WinterGuard can be applied when the temperature falls below 40° F.
- A. True.  
B. False.
- 5-12. For ice dam protection, WinterGuard  must be applied along the eaves and up the roof no less than 36" beyond the interior wall line.
- A. True.  
B. False.
- 5-13. When applying Flintlastic SA, you have the option of installing either a 2-ply or 3-ply roof system.
- A. True.  
B. False.

Test on-line @ [www.certainteed.com/msatest](http://www.certainteed.com/msatest).